

# 45° Flare

FLARE

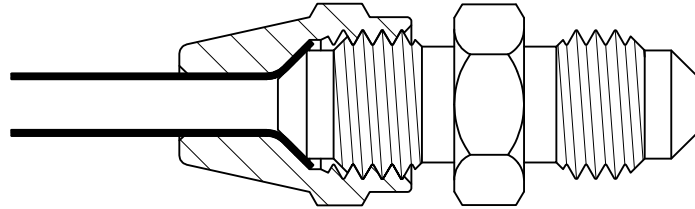

TITON Flare Fittings are manufactured especially with hazardous liquids and gasses in mind. They are available in sizes ranging from 1/8" to 3/4", and are manufactured from high quality DZR grade brass alloy . All flare fittings conform to the following standards: AS D26, AS3688, AG 601-1995, NZG 1993/76.

### ADVANTAGES

May be assembled/disassembled numerous times. When used with the appropriate tubing, they can withstand high pressures. For improved resistance to mechanical vibration, the Long Flare Nut may be used.

### APPLICATIONS

Use with copper, brass, aluminium, and flareable steel pipe. Install where medium to high pressures are encountered. Flare Fittings, when used with the Long Flare Nut, provide good resistance to vibration. Ideal for use with fuel, oil, air, water and Natural Gas lines. In Applications where temperatures extremes are encountered we recommend the use of stress-relieved fittings. Please contact our technical sales department for more information.

### WORKING PRESSURES

TITON Flare Fittings are able to withstand high pressures, use the table below as a guideline. Usually, pressures are determined by the pipe used, rather than the Flare Fitting.

### SPECIAL SIZES

Other sizes not specified are available upon request.

### ASSEMBLY

- I. Slide nut, tapered end first, onto tubing.
- II. Using a 45° flaring tool, flare end of tube until flare just fits inside nut. (On thin wall tubing it is recommended a double flare is used to prevent pinch off.)
- III. Assemble to fitting body. Nut should be tightened hand tight.
- IV. Using a wrench, tighten until a leak-proof, metal to metal joint is achieved. To avoid premature failure of the fitting, do not over-tighten.

Tube Size	Hydraulic kPa [PSI]	Pneumatic kPa [PSI]
1/8	17250 [2500]	4800 [700]
3/16	17250 [2500]	4800 [700]
1/4	13750 [2000]	4800 [700]
5/16	13750 [2000]	4800 [700]
3/8	10400 [1500]	2750 [400]
1/2	7000 [1020]	1750 [250]
5/8	7000 [1020]	1750 [250]
3/4	7000 [1020]	1750 [250]

## 45° Flare

<p style="font-size: 24pt; font-weight: bold; margin-bottom: 10px;">39P</p>	<p style="text-align: center; font-weight: bold; margin-bottom: 10px;">Flare Plug</p> <table border="1" style="width: 100%; border-collapse: collapse;"> <thead> <tr style="background-color: #ffffcc;"> <th style="text-align: left;">Part Number</th> <th style="text-align: center;">Standard Pack</th> <th style="text-align: center;">Tube</th> <th style="text-align: center;">Pipe Thread</th> <th style="text-align: center;">Price Per Piece</th> </tr> </thead> <tbody> <tr><td>39P04</td><td style="text-align: center;">5</td><td style="text-align: center;">1/4</td><td style="text-align: center;">-</td><td></td></tr> <tr><td>39P05</td><td style="text-align: center;">5</td><td style="text-align: center;">5/16</td><td style="text-align: center;">-</td><td></td></tr> <tr><td>39P06</td><td style="text-align: center;">5</td><td style="text-align: center;">3/8</td><td style="text-align: center;">-</td><td></td></tr> <tr><td>39P08</td><td style="text-align: center;">5</td><td style="text-align: center;">1/2</td><td style="text-align: center;">-</td><td></td></tr> <tr><td>39P10</td><td style="text-align: center;">5</td><td style="text-align: center;">5/8</td><td style="text-align: center;">-</td><td></td></tr> </tbody> </table>	Part Number	Standard Pack	Tube	Pipe Thread	Price Per Piece	39P04	5	1/4	-		39P05	5	5/16	-		39P06	5	3/8	-		39P08	5	1/2	-		39P10	5	5/8	-																
Part Number	Standard Pack	Tube	Pipe Thread	Price Per Piece																																										
39P04	5	1/4	-																																											
39P05	5	5/16	-																																											
39P06	5	3/8	-																																											
39P08	5	1/2	-																																											
39P10	5	5/8	-																																											
<p style="font-size: 24pt; font-weight: bold; margin-bottom: 10px;">40C</p>	<p style="text-align: center; font-weight: bold; margin-bottom: 10px;">Flare Cap</p> <table border="1" style="width: 100%; border-collapse: collapse;"> <thead> <tr style="background-color: #ffffcc;"> <th style="text-align: left;">Part Number</th> <th style="text-align: center;">Standard Pack</th> <th style="text-align: center;">Tube</th> <th style="text-align: center;">Pipe Thread</th> <th style="text-align: center;">Price Per Piece</th> </tr> </thead> <tbody> <tr><td>40C04</td><td style="text-align: center;">5</td><td style="text-align: center;">1/4</td><td style="text-align: center;">-</td><td></td></tr> <tr><td>40C05</td><td style="text-align: center;">5</td><td style="text-align: center;">5/16</td><td style="text-align: center;">-</td><td></td></tr> <tr><td>40C06</td><td style="text-align: center;">5</td><td style="text-align: center;">3/8</td><td style="text-align: center;">-</td><td></td></tr> <tr><td>40C08</td><td style="text-align: center;">5</td><td style="text-align: center;">1/2</td><td style="text-align: center;">-</td><td></td></tr> </tbody> </table>	Part Number	Standard Pack	Tube	Pipe Thread	Price Per Piece	40C04	5	1/4	-		40C05	5	5/16	-		40C06	5	3/8	-		40C08	5	1/2	-																					
Part Number	Standard Pack	Tube	Pipe Thread	Price Per Piece																																										
40C04	5	1/4	-																																											
40C05	5	5/16	-																																											
40C06	5	3/8	-																																											
40C08	5	1/2	-																																											
<p style="font-size: 24pt; font-weight: bold; margin-bottom: 10px;">41S</p>	<p style="text-align: center; font-weight: bold; margin-bottom: 10px;">Short Flare Nut</p> <table border="1" style="width: 100%; border-collapse: collapse;"> <thead> <tr style="background-color: #ffffcc;"> <th style="text-align: left;">Part Number</th> <th style="text-align: center;">Standard Pack</th> <th style="text-align: center;">Tube</th> <th style="text-align: center;">Pipe Thread</th> <th style="text-align: center;">Price Per Piece</th> </tr> </thead> <tbody> <tr><td>41S02</td><td style="text-align: center;">50</td><td style="text-align: center;">1/8</td><td style="text-align: center;">-</td><td></td></tr> <tr><td>41S03</td><td style="text-align: center;">50</td><td style="text-align: center;">3/16</td><td style="text-align: center;">-</td><td></td></tr> <tr><td>41S04</td><td style="text-align: center;">50</td><td style="text-align: center;">1/4</td><td style="text-align: center;">-</td><td></td></tr> <tr><td>41S05</td><td style="text-align: center;">50</td><td style="text-align: center;">5/16</td><td style="text-align: center;">-</td><td></td></tr> <tr><td>41S06</td><td style="text-align: center;">25</td><td style="text-align: center;">3/8</td><td style="text-align: center;">-</td><td></td></tr> <tr><td>41S08</td><td style="text-align: center;">20</td><td style="text-align: center;">1/2</td><td style="text-align: center;">-</td><td></td></tr> <tr><td>41S10</td><td style="text-align: center;">10</td><td style="text-align: center;">5/8</td><td style="text-align: center;">-</td><td></td></tr> <tr><td>41S12</td><td style="text-align: center;">10</td><td style="text-align: center;">3/4</td><td style="text-align: center;">-</td><td></td></tr> </tbody> </table>	Part Number	Standard Pack	Tube	Pipe Thread	Price Per Piece	41S02	50	1/8	-		41S03	50	3/16	-		41S04	50	1/4	-		41S05	50	5/16	-		41S06	25	3/8	-		41S08	20	1/2	-		41S10	10	5/8	-		41S12	10	3/4	-	
Part Number	Standard Pack	Tube	Pipe Thread	Price Per Piece																																										
41S02	50	1/8	-																																											
41S03	50	3/16	-																																											
41S04	50	1/4	-																																											
41S05	50	5/16	-																																											
41S06	25	3/8	-																																											
41S08	20	1/2	-																																											
41S10	10	5/8	-																																											
41S12	10	3/4	-																																											

# 45° Flare

**F  
L  
A  
R  
E**

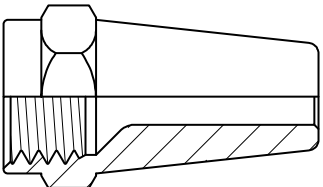
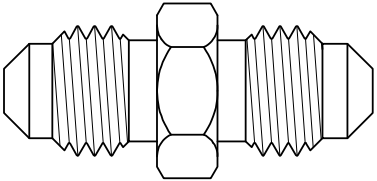
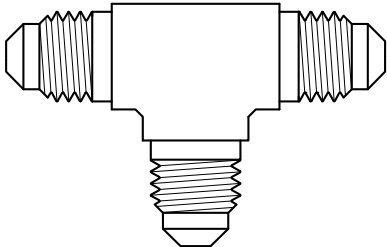
<b>Long Flare Nut</b>					<b>41</b>
Offers Improved Resistance To Vibration.					
Part Number	Standard Pack	Tube	Pipe Thread	Price Per Piece	
4102	25	1/8	-		
4103	25	3/16	-		
4104	25	1/4	-		
4105	25	5/16	-		
4106	25	3/8	-		
4108	20	1/2	-		
4110	10	5/8	-		
4112	10	3/4	-		
<b>Double Flare Union</b>					<b>42</b>
For Reducing Unions See No 58.					
Part Number	Standard Pack	Tube	Pipe Thread	Price Per Piece	
4202	20	1/8	-		
4203	20	3/16	-		
4204	25	1/4	-		
4205	25	5/16	-		
4206	25	3/8	-		
4208	10	1/2	-		
4210	10	5/8	-		
4212	10	3/4	-		
<b>Flare Tee</b>					<b>44</b>
For Reducing Unions See No 58.					
Part Number	Standard Pack	Tube	Pipe Thread	Price Per Piece	
4402	10	1/8	-		
4403	10	3/16	-		
4404	10	1/4	-		
4405	10	5/16	-		
4406	10	3/8	-		
4408	10	1/2	-		
4410	10	5/8	-		

## 45° Flare

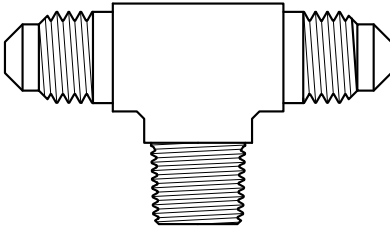
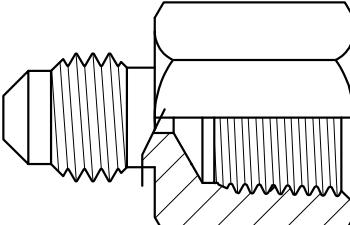
<div style="font-size: 2em; font-weight: bold; margin-bottom: 10px;">45</div> 	<h3>Flare Male Branch Tee</h3>																																																																																					
	<table border="1" style="width: 100%; border-collapse: collapse;"> <thead> <tr style="background-color: #ffffcc;"> <th style="text-align: left;">Part Number</th> <th style="text-align: center;">Standard Pack</th> <th style="text-align: center;">Tube</th> <th style="text-align: center;">Pipe Thread</th> <th style="text-align: center;">Price Per Piece</th> </tr> </thead> <tbody> <tr><td>450302</td><td style="text-align: center;">10</td><td style="text-align: center;">3/16</td><td style="text-align: center;">1/8 BSPT</td><td></td></tr> <tr><td>450402</td><td style="text-align: center;">10</td><td style="text-align: center;">1/4</td><td style="text-align: center;">1/8 BSPT</td><td></td></tr> <tr><td>450404</td><td style="text-align: center;">10</td><td style="text-align: center;">1/4</td><td style="text-align: center;">1/4 BSPT</td><td></td></tr> <tr><td>450502</td><td style="text-align: center;">10</td><td style="text-align: center;">5/16</td><td style="text-align: center;">1/8 BSPT</td><td></td></tr> <tr><td>450604</td><td style="text-align: center;">10</td><td style="text-align: center;">3/8</td><td style="text-align: center;">1/4 BSPT</td><td></td></tr> <tr><td>450806</td><td style="text-align: center;">10</td><td style="text-align: center;">1/2</td><td style="text-align: center;">3/8 BSPT</td><td></td></tr> </tbody> </table>	Part Number	Standard Pack	Tube	Pipe Thread	Price Per Piece	450302	10	3/16	1/8 BSPT		450402	10	1/4	1/8 BSPT		450404	10	1/4	1/4 BSPT		450502	10	5/16	1/8 BSPT		450604	10	3/8	1/4 BSPT		450806	10	1/2	3/8 BSPT																																																			
Part Number	Standard Pack	Tube	Pipe Thread	Price Per Piece																																																																																		
450302	10	3/16	1/8 BSPT																																																																																			
450402	10	1/4	1/8 BSPT																																																																																			
450404	10	1/4	1/4 BSPT																																																																																			
450502	10	5/16	1/8 BSPT																																																																																			
450604	10	3/8	1/4 BSPT																																																																																			
450806	10	1/2	3/8 BSPT																																																																																			
<div style="font-size: 2em; font-weight: bold; margin-bottom: 10px;">46</div> 	<h3>Flare Female Connector</h3>																																																																																					
	<table border="1" style="width: 100%; border-collapse: collapse;"> <thead> <tr style="background-color: #ffffcc;"> <th style="text-align: left;">Part Number</th> <th style="text-align: center;">Standard Pack</th> <th style="text-align: center;">Tube</th> <th style="text-align: center;">Pipe Thread</th> <th style="text-align: center;">Price Per Piece</th> </tr> </thead> <tbody> <tr><td>460202</td><td style="text-align: center;">10</td><td style="text-align: center;">1/8</td><td style="text-align: center;">1/8 BSPP</td><td></td></tr> <tr><td>460302</td><td style="text-align: center;">10</td><td style="text-align: center;">3/16</td><td style="text-align: center;">1/8 BSPP</td><td></td></tr> <tr><td>460402</td><td style="text-align: center;">10</td><td style="text-align: center;">1/4</td><td style="text-align: center;">1/8 BSPP</td><td></td></tr> <tr><td>460404</td><td style="text-align: center;">10</td><td style="text-align: center;">1/4</td><td style="text-align: center;">1/4 BSPP</td><td></td></tr> <tr><td>460406</td><td style="text-align: center;">10</td><td style="text-align: center;">1/4</td><td style="text-align: center;">3/8 BSPP</td><td></td></tr> <tr><td>460502</td><td style="text-align: center;">10</td><td style="text-align: center;">5/16</td><td style="text-align: center;">1/8 BSPP</td><td></td></tr> <tr><td>460504</td><td style="text-align: center;">10</td><td style="text-align: center;">5/16</td><td style="text-align: center;">1/4 BSPP</td><td></td></tr> <tr><td>460602</td><td style="text-align: center;">10</td><td style="text-align: center;">3/8</td><td style="text-align: center;">1/8 BSPP</td><td></td></tr> <tr><td>460604</td><td style="text-align: center;">10</td><td style="text-align: center;">3/8</td><td style="text-align: center;">1/4 BSPP</td><td></td></tr> <tr><td>460606</td><td style="text-align: center;">10</td><td style="text-align: center;">3/8</td><td style="text-align: center;">3/8 BSPP</td><td></td></tr> <tr><td>460608</td><td style="text-align: center;">10</td><td style="text-align: center;">3/8</td><td style="text-align: center;">1/2 BSPP</td><td></td></tr> <tr><td>460804</td><td style="text-align: center;">10</td><td style="text-align: center;">1/2</td><td style="text-align: center;">1/4 BSPP</td><td></td></tr> <tr><td>460806</td><td style="text-align: center;">10</td><td style="text-align: center;">1/2</td><td style="text-align: center;">3/8 BSPP</td><td></td></tr> <tr><td>460808</td><td style="text-align: center;">10</td><td style="text-align: center;">1/2</td><td style="text-align: center;">1/2 BSPP</td><td></td></tr> <tr><td>461208</td><td style="text-align: center;">10</td><td style="text-align: center;">3/4</td><td style="text-align: center;">1/2 BSPP</td><td></td></tr> <tr><td>461212</td><td style="text-align: center;">1</td><td style="text-align: center;">3/4</td><td style="text-align: center;">3/4 BSPP</td><td></td></tr> </tbody> </table>	Part Number	Standard Pack	Tube	Pipe Thread	Price Per Piece	460202	10	1/8	1/8 BSPP		460302	10	3/16	1/8 BSPP		460402	10	1/4	1/8 BSPP		460404	10	1/4	1/4 BSPP		460406	10	1/4	3/8 BSPP		460502	10	5/16	1/8 BSPP		460504	10	5/16	1/4 BSPP		460602	10	3/8	1/8 BSPP		460604	10	3/8	1/4 BSPP		460606	10	3/8	3/8 BSPP		460608	10	3/8	1/2 BSPP		460804	10	1/2	1/4 BSPP		460806	10	1/2	3/8 BSPP		460808	10	1/2	1/2 BSPP		461208	10	3/4	1/2 BSPP		461212	1	3/4	3/4 BSPP	
Part Number	Standard Pack	Tube	Pipe Thread	Price Per Piece																																																																																		
460202	10	1/8	1/8 BSPP																																																																																			
460302	10	3/16	1/8 BSPP																																																																																			
460402	10	1/4	1/8 BSPP																																																																																			
460404	10	1/4	1/4 BSPP																																																																																			
460406	10	1/4	3/8 BSPP																																																																																			
460502	10	5/16	1/8 BSPP																																																																																			
460504	10	5/16	1/4 BSPP																																																																																			
460602	10	3/8	1/8 BSPP																																																																																			
460604	10	3/8	1/4 BSPP																																																																																			
460606	10	3/8	3/8 BSPP																																																																																			
460608	10	3/8	1/2 BSPP																																																																																			
460804	10	1/2	1/4 BSPP																																																																																			
460806	10	1/2	3/8 BSPP																																																																																			
460808	10	1/2	1/2 BSPP																																																																																			
461208	10	3/4	1/2 BSPP																																																																																			
461212	1	3/4	3/4 BSPP																																																																																			

# 45° Flare

**F  
L  
A  
R  
E**

Flare Male Connector					48
Part Number	Standard Pack	Tube	Pipe Thread	Price Per Piece	
480202	20	1/8	1/8 BSPT		
480302	20	3/16	1/8 BSPT		
480304	-	3/16	1/4 BSPT		
480402	20	1/4	1/8 BSPT		
480404	20	1/4	1/4 BSPT		
480406	20	1/4	3/8 BSPT		
480408	20	1/4	1/2 BSPT		
480502	20	5/16	1/8 BSPT		
480504	20	5/16	1/4 BSPT		
480506	20	5/16	3/8 BSPT		
480508	-	5/16	1/2 BSPT		
480602	20	3/8	1/8 BSPT		
480604	20	3/8	1/4 BSPT		
480606	20	3/8	3/8 BSPT		
480608	20	3/8	1/2 BSPT		
480612	10	3/8	3/4 BSPT		
480804	20	1/2	1/4 BSPT		
480806	10	1/2	3/8 BSPT		
480808	10	1/2	1/2 BSPT		
480812	-	1/2	3/4 BSPT		
481006	5	5/8	3/8 BSPT		
481008	5	5/8	1/2 BSPT		
481012	5	5/8	3/4 BSPT		
481208	5	3/4	1/2 BSPT		
481212	5	3/4	3/4 BSPT		

Flare Male Elbow					49
Part Number	Standard Pack	Tube	Pipe Thread	Price Per Piece	
490202	20	1/8	1/8 BSPT		
490302	20	3/16	1/8 BSPT		
490402	25	1/4	1/8 BSPT		
490404	25	1/4	1/4 BSPT		
490406	25	1/4	3/8 BSPT		
490502	25	5/16	1/8 BSPT		
490504	25	5/16	1/4 BSPT		
490506	25	5/16	3/8 BSPT		

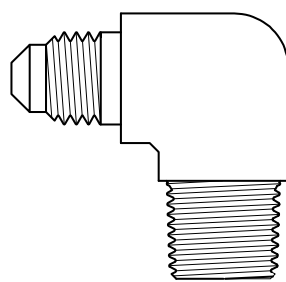
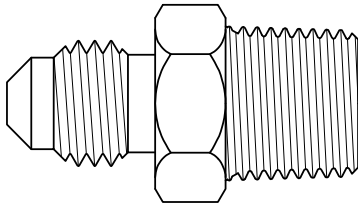

Continued on next page...

\* All prices are in New Zealand Dollars ex GST

## 45° Flare

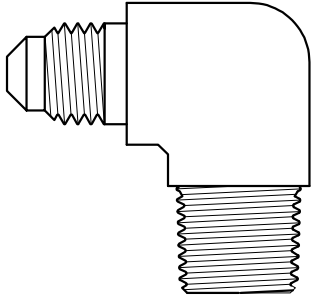
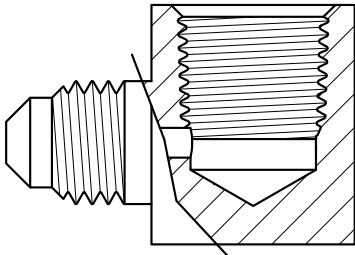
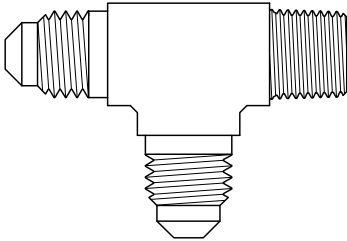
<p>...Continued from previous page</p> <p style="font-size: 24pt; font-weight: bold;">49</p> 	<p style="text-align: center; font-weight: bold;">Flare Male Elbow</p> <table border="1" style="width: 100%; border-collapse: collapse;"> <thead> <tr style="background-color: #ffffcc;"> <th style="text-align: center;">Part Number</th> <th style="text-align: center;">Standard Pack</th> <th style="text-align: center;">Tube</th> <th style="text-align: center;">Pipe Thread</th> <th style="text-align: center;">Price Per Piece</th> </tr> </thead> <tbody> <tr><td style="text-align: center;">490602</td><td style="text-align: center;">20</td><td style="text-align: center;">3/8</td><td style="text-align: center;">1/8 BSPT</td><td></td></tr> <tr><td style="text-align: center;">490604</td><td style="text-align: center;">20</td><td style="text-align: center;">3/8</td><td style="text-align: center;">1/4 BSPT</td><td></td></tr> <tr><td style="text-align: center;">490606</td><td style="text-align: center;">10</td><td style="text-align: center;">3/8</td><td style="text-align: center;">3/8 BSPT</td><td></td></tr> <tr><td style="text-align: center;">490608</td><td style="text-align: center;">10</td><td style="text-align: center;">3/8</td><td style="text-align: center;">1/2 BSPT</td><td></td></tr> <tr><td style="text-align: center;">490804</td><td style="text-align: center;">10</td><td style="text-align: center;">1/2</td><td style="text-align: center;">1/4 BSPT</td><td></td></tr> <tr><td style="text-align: center;">490806</td><td style="text-align: center;">10</td><td style="text-align: center;">1/2</td><td style="text-align: center;">3/8 BSPT</td><td></td></tr> <tr><td style="text-align: center;">490808</td><td style="text-align: center;">10</td><td style="text-align: center;">1/2</td><td style="text-align: center;">1/2 BSPT</td><td></td></tr> <tr><td style="text-align: center;">491008</td><td style="text-align: center;">5</td><td style="text-align: center;">5/8</td><td style="text-align: center;">1/2 BSPT</td><td></td></tr> <tr><td style="text-align: center;">491208</td><td style="text-align: center;">5</td><td style="text-align: center;">5/8</td><td style="text-align: center;">1/2 BSPT</td><td></td></tr> </tbody> </table>	Part Number	Standard Pack	Tube	Pipe Thread	Price Per Piece	490602	20	3/8	1/8 BSPT		490604	20	3/8	1/4 BSPT		490606	10	3/8	3/8 BSPT		490608	10	3/8	1/2 BSPT		490804	10	1/2	1/4 BSPT		490806	10	1/2	3/8 BSPT		490808	10	1/2	1/2 BSPT		491008	5	5/8	1/2 BSPT		491208	5	5/8	1/2 BSPT	
Part Number	Standard Pack	Tube	Pipe Thread	Price Per Piece																																															
490602	20	3/8	1/8 BSPT																																																
490604	20	3/8	1/4 BSPT																																																
490606	10	3/8	3/8 BSPT																																																
490608	10	3/8	1/2 BSPT																																																
490804	10	1/2	1/4 BSPT																																																
490806	10	1/2	3/8 BSPT																																																
490808	10	1/2	1/2 BSPT																																																
491008	5	5/8	1/2 BSPT																																																
491208	5	5/8	1/2 BSPT																																																
<p style="font-size: 24pt; font-weight: bold;">50</p> 	<p style="text-align: center; font-weight: bold;">Flare Female Elbow</p> <table border="1" style="width: 100%; border-collapse: collapse;"> <thead> <tr style="background-color: #ffffcc;"> <th style="text-align: center;">Part Number</th> <th style="text-align: center;">Standard Pack</th> <th style="text-align: center;">Tube</th> <th style="text-align: center;">Pipe Thread</th> <th style="text-align: center;">Price Per Piece</th> </tr> </thead> <tbody> <tr><td style="text-align: center;">500402</td><td style="text-align: center;">1</td><td style="text-align: center;">1/4</td><td style="text-align: center;">1/8 BSPP</td><td></td></tr> <tr><td style="text-align: center;">500502</td><td style="text-align: center;">1</td><td style="text-align: center;">5/16</td><td style="text-align: center;">1/8 BSPP</td><td></td></tr> <tr><td style="text-align: center;">500604</td><td style="text-align: center;">1</td><td style="text-align: center;">3/8</td><td style="text-align: center;">1/4 BSPP</td><td></td></tr> <tr><td style="text-align: center;">500806</td><td style="text-align: center;">1</td><td style="text-align: center;">1/2</td><td style="text-align: center;">3/8 BSPP</td><td></td></tr> </tbody> </table>	Part Number	Standard Pack	Tube	Pipe Thread	Price Per Piece	500402	1	1/4	1/8 BSPP		500502	1	5/16	1/8 BSPP		500604	1	3/8	1/4 BSPP		500806	1	1/2	3/8 BSPP																										
Part Number	Standard Pack	Tube	Pipe Thread	Price Per Piece																																															
500402	1	1/4	1/8 BSPP																																																
500502	1	5/16	1/8 BSPP																																																
500604	1	3/8	1/4 BSPP																																																
500806	1	1/2	3/8 BSPP																																																
<p style="font-size: 24pt; font-weight: bold;">51</p> 	<p style="text-align: center; font-weight: bold;">Flare Male Run Tee</p> <table border="1" style="width: 100%; border-collapse: collapse;"> <thead> <tr style="background-color: #ffffcc;"> <th style="text-align: center;">Part Number</th> <th style="text-align: center;">Standard Pack</th> <th style="text-align: center;">Tube</th> <th style="text-align: center;">Pipe Thread</th> <th style="text-align: center;">Price Per Piece</th> </tr> </thead> <tbody> <tr><td style="text-align: center;">510402</td><td style="text-align: center;">1</td><td style="text-align: center;">1/4</td><td style="text-align: center;">1/8 BSPT</td><td></td></tr> <tr><td style="text-align: center;">510604</td><td style="text-align: center;">1</td><td style="text-align: center;">5/16</td><td style="text-align: center;">1/4 BSPT</td><td></td></tr> <tr><td style="text-align: center;">510806</td><td style="text-align: center;">1</td><td style="text-align: center;">3/8</td><td style="text-align: center;">3/8 BSPT</td><td></td></tr> </tbody> </table>	Part Number	Standard Pack	Tube	Pipe Thread	Price Per Piece	510402	1	1/4	1/8 BSPT		510604	1	5/16	1/4 BSPT		510806	1	3/8	3/8 BSPT																															
Part Number	Standard Pack	Tube	Pipe Thread	Price Per Piece																																															
510402	1	1/4	1/8 BSPT																																																
510604	1	5/16	1/4 BSPT																																																
510806	1	3/8	3/8 BSPT																																																

# 45° Flare

FLARE

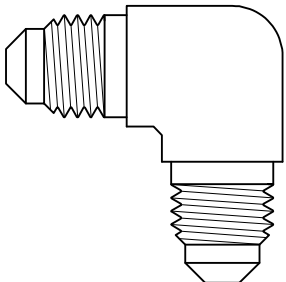
Flare 90° Elbow					<div style="font-size: 2em; font-weight: bold;">55</div> 
Part Number	Standard Pack	Tube	Pipe Thread	Price Per Piece	
5502	10	1/8	-		
5503	10	3/16	-		
5504	10	1/4	-		
5505	10	5/16	-		
5506	10	3/8	-		
5508	10	1/2	-		
5510	10	5/8	-		

Reducing Flare Union					<div style="font-size: 2em; font-weight: bold;">58</div> 
Part Number	Standard Pack	Tube	Tube	Price Per Piece	
580403	10	1/4	3/16		
580504	10	5/16	1/4		
580604	10	3/8	1/4		
580605	10	3/8	5/16		
580806	10	1/2	3/8		

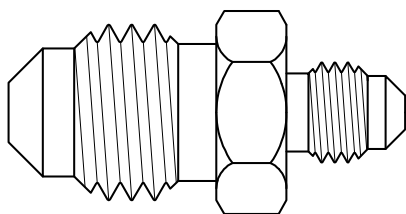
# 45° Gas Flare

<h2 style="margin: 0;">GFC</h2> 	<h3 style="text-align: center; margin: 0;">Gas Flare Assembly</h3> <p style="text-align: center; margin: 0;">Consists of GFN Nut and GFM Connector</p> <table border="1" style="width: 100%; border-collapse: collapse; margin-top: 10px;"> <thead> <tr style="background-color: #ffffcc;"> <th style="text-align: left;">Part Number</th> <th style="text-align: center;">Standard Pack</th> <th style="text-align: center;">Tube</th> <th style="text-align: center;">Pipe Thread</th> <th style="text-align: center;">Price Per Piece</th> </tr> </thead> <tbody> <tr> <td>GFC1006</td> <td style="text-align: center;">10</td> <td style="text-align: center;">10 mm</td> <td style="text-align: center;">3/8 BSPT</td> <td></td> </tr> <tr> <td>GFC1008</td> <td style="text-align: center;">10</td> <td style="text-align: center;">10 mm</td> <td style="text-align: center;">1/2 BSPT</td> <td></td> </tr> <tr> <td>GFC1508</td> <td style="text-align: center;">10</td> <td style="text-align: center;">15 mm</td> <td style="text-align: center;">1/2 BSPT</td> <td></td> </tr> <tr> <td>GFC2012</td> <td style="text-align: center;">10</td> <td style="text-align: center;">20 mm</td> <td style="text-align: center;">3/4 BSPT</td> <td></td> </tr> </tbody> </table>	Part Number	Standard Pack	Tube	Pipe Thread	Price Per Piece	GFC1006	10	10 mm	3/8 BSPT		GFC1008	10	10 mm	1/2 BSPT		GFC1508	10	15 mm	1/2 BSPT		GFC2012	10	20 mm	3/4 BSPT	
Part Number	Standard Pack	Tube	Pipe Thread	Price Per Piece																						
GFC1006	10	10 mm	3/8 BSPT																							
GFC1008	10	10 mm	1/2 BSPT																							
GFC1508	10	15 mm	1/2 BSPT																							
GFC2012	10	20 mm	3/4 BSPT																							
<h2 style="margin: 0;">GFF</h2>  <p style="margin-top: 10px;"><b>Stress Relieved</b></p>	<h3 style="text-align: center; margin: 0;">Gas Flare Female Connector</h3> <table border="1" style="width: 100%; border-collapse: collapse; margin-top: 10px;"> <thead> <tr style="background-color: #ffffcc;"> <th style="text-align: left;">Part Number</th> <th style="text-align: center;">Standard Pack</th> <th style="text-align: center;">Tube</th> <th style="text-align: center;">Pipe Thread</th> <th style="text-align: center;">Price Per Piece</th> </tr> </thead> <tbody> <tr> <td>GFF1508</td> <td style="text-align: center;">10</td> <td style="text-align: center;">15 mm</td> <td style="text-align: center;">1/2 BSPT</td> <td></td> </tr> <tr> <td>GFF2012</td> <td style="text-align: center;">10</td> <td style="text-align: center;">20 mm</td> <td style="text-align: center;">3/4 BSPT</td> <td></td> </tr> </tbody> </table>	Part Number	Standard Pack	Tube	Pipe Thread	Price Per Piece	GFF1508	10	15 mm	1/2 BSPT		GFF2012	10	20 mm	3/4 BSPT											
Part Number	Standard Pack	Tube	Pipe Thread	Price Per Piece																						
GFF1508	10	15 mm	1/2 BSPT																							
GFF2012	10	20 mm	3/4 BSPT																							
<h2 style="margin: 0;">GFN</h2>  <p style="margin-top: 10px;"><b>Stress Relieved</b></p>	<h3 style="text-align: center; margin: 0;">Gas Flare Nut</h3> <table border="1" style="width: 100%; border-collapse: collapse; margin-top: 10px;"> <thead> <tr style="background-color: #ffffcc;"> <th style="text-align: left;">Part Number</th> <th style="text-align: center;">Standard Pack</th> <th style="text-align: center;">Tube</th> <th style="text-align: center;">Pipe Thread</th> <th style="text-align: center;">Price Per Piece</th> </tr> </thead> <tbody> <tr> <td>GFN10</td> <td style="text-align: center;">10</td> <td style="text-align: center;">10 mm</td> <td style="text-align: center;">-</td> <td></td> </tr> <tr> <td>GFN15</td> <td style="text-align: center;">10</td> <td style="text-align: center;">15 mm</td> <td style="text-align: center;">-</td> <td></td> </tr> <tr> <td>GFN20</td> <td style="text-align: center;">10</td> <td style="text-align: center;">20 mm</td> <td style="text-align: center;">-</td> <td></td> </tr> </tbody> </table>	Part Number	Standard Pack	Tube	Pipe Thread	Price Per Piece	GFN10	10	10 mm	-		GFN15	10	15 mm	-		GFN20	10	20 mm	-						
Part Number	Standard Pack	Tube	Pipe Thread	Price Per Piece																						
GFN10	10	10 mm	-																							
GFN15	10	15 mm	-																							
GFN20	10	20 mm	-																							

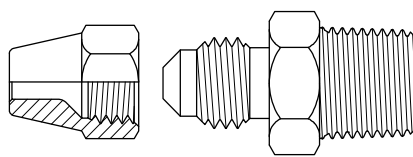
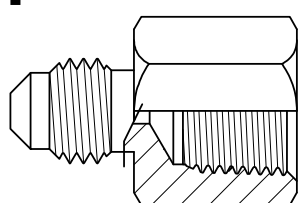
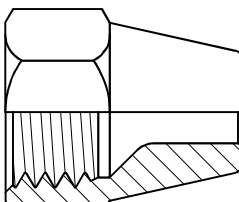

# 45° Inverted Flare

**F  
L  
A  
R  
E**

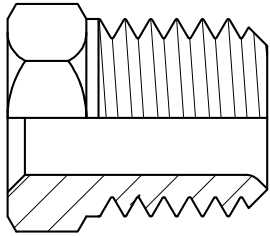
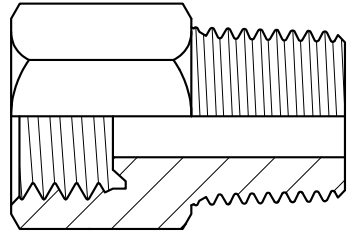
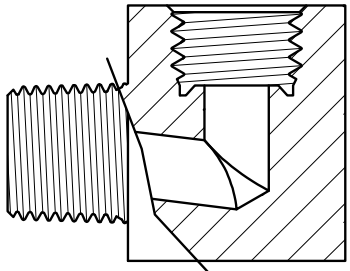
Inverted Flare Nut					<div style="text-align: right; font-size: 2em; font-weight: bold;">105</div> 
Part Number	Standard Pack	Tube	Pipe Thread	Price Per Piece	
10502	20	1/8	-		
10503	20	3/16	-		
10504	20	1/4	-		
10505	20	5/16	-		
10506	20	3/8	-		
10508	10	1/2	-		
Inverted Flare Male Connector					<div style="text-align: right; font-size: 2em; font-weight: bold;">200</div> 
Part Number	Standard Pack	Tube	Pipe Thread	Price Per Piece	
2000302	20	3/16	1/8 BSPT		
2000402	20	1/4	1/8 BSPT		
2000404	20	1/4	1/4 BSPT		
2000502	20	5/16	1/8 BSPT		
2000504	20	5/16	1/4 BSPT		
2000604	10	3/8	1/4 BSPT		
2000806	10	1/2	3/8 BSPT		
Inverted Flare Male Elbow					<div style="text-align: right; font-size: 2em; font-weight: bold;">400</div> 
Part Number	Standard Pack	Tube	Pipe Thread	Price Per Piece	
4000202	10	1/8	1/8 BSPT		
4000302	10	3/16	1/8 BSPT		
4000402	20	1/4	1/8 BSPT		
4000404	20	1/4	1/4 BSPT		
4000502	20	5/16	1/8 BSPT		
4000504	20	5/16	1/4 BSPT		
4000604	10	3/8	1/4 BSPT		
4000606	10	3/8	3/8 BSPT		
4000806	10	1/2	3/8 BSPT		

# Profiles

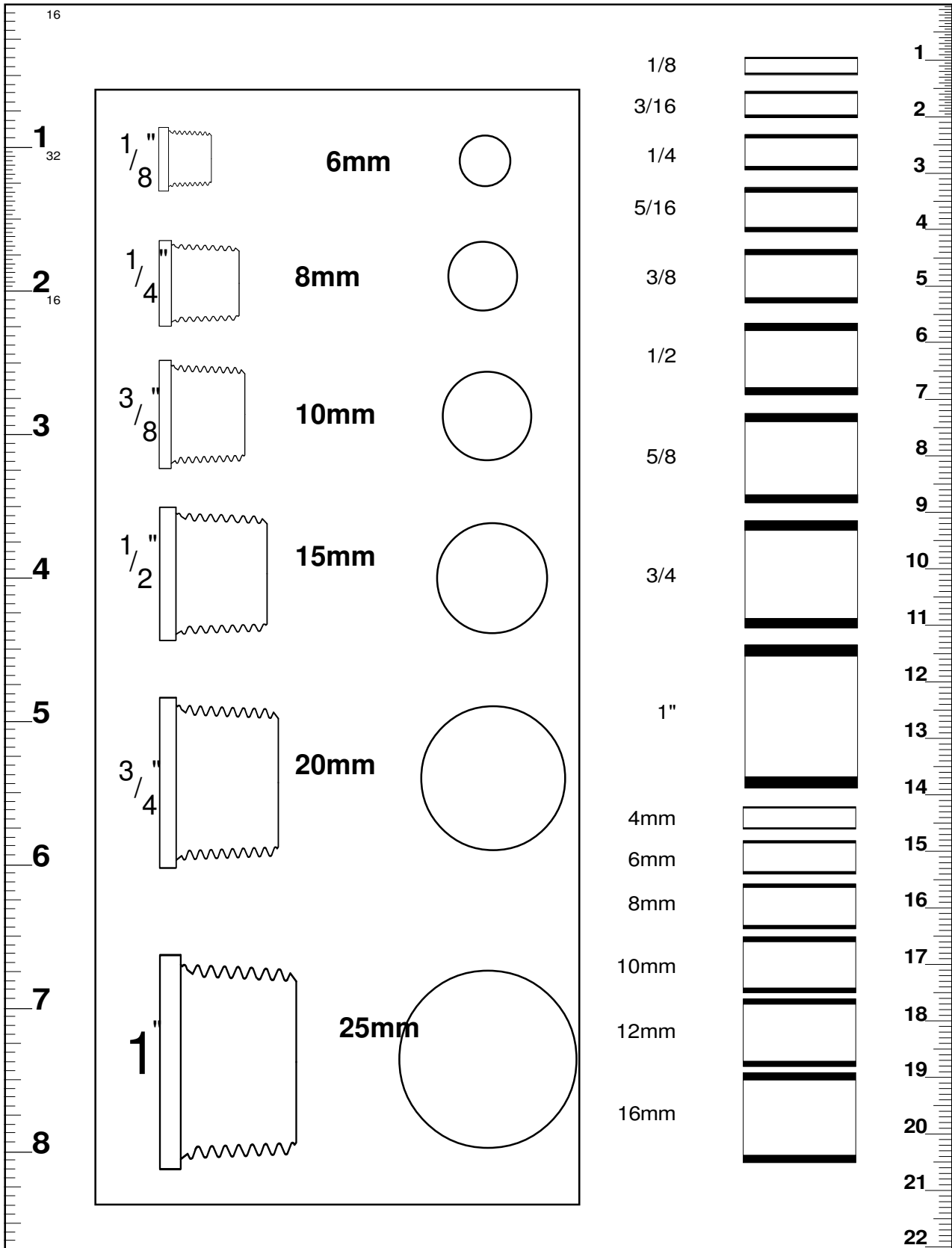

# Compression Fittings

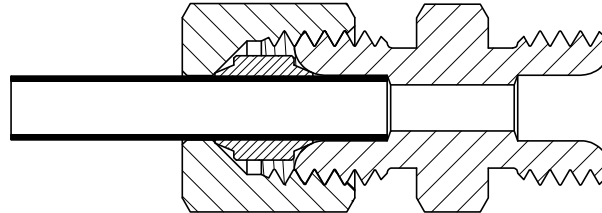

TITON Compression Fittings are designed to comply with established industry standards. This economical fitting is available in a wide range of off-the-shelf sizes and styles. They are manufactured from high quality DZR brass alloy.

### ADVANTAGES

Simple to assemble. No soldering, flaring or deburring is necessary. Suitable for use in a wide variety of applications.

### APPLICATIONS

May be used with copper, aluminium, brass, and plastic tubing. Use with steel tubing is not recommended. Installation should be where low to medium pressures are encountered, and modest tube vibration/movement is involved. Suitable for hazardous liquids, oils, and fuel. **Not recommended for use with gas**

### WORKING PRESSURES

Generally, working pressure is dependant upon the type of tubing used and not the fitting. Consequently the table shown below should be used as a guide only.

### ASSEMBLY

- I. Slide nut then sleeve onto tube ensuring threaded end of nut is facing the sleeve.
- II. If using a plastic tube, push a 261 Insert into tube to prevent tube from collapsing.
- III. Insert the tube into the fitting until the tube has bottomed onto the fitting shoulder.
- IV. Screw nut onto the fitting and tighten "hand tight". **Using the table below, follow the number of additional wrench turns.**

Tube Size	Hydraulic kPa [PSI]	Pneumatic kPa [PSI]	Wrench Turns
1/8	3500 [500]	2000 [290]	1
3/16	3500 [500]	1750 [250]	1
1/4	2750 [400]	1400 [200]	1
5/16	2750 [400]	1400 [200]	1
3/8	2000 [290]	1050 [150]	1
1/2	2000 [290]	1050 [150]	1½
5/8	1400 [200]	700 [100]	1½
3/4	1400 [200]	700 [100]	1½

C  
O  
M  
P

# Compression Fittings

COMP

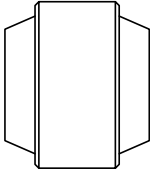
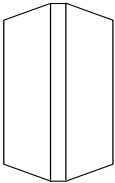
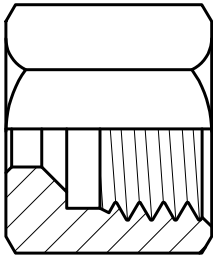
<p><b>60N</b></p> 	<p><b>Sleeve</b> For All Materials. Ideal For Nylon</p>					
	Part Number	Standard Pack	Tube	Pipe Thread	Price Per Piece	
	60N02	100	1/8	-		
	60N03	100	3/16	-		
	60N04	100	1/4	-		
	60N05	100	5/16	-		
	60N06	100	3/8	-		
	60N08	50	1/2	-		
	60N10	50	5/8	-		
	60N12	50	3/4	-		
	60N16	1	1"	-		
	<p><b>60</b></p> 	<p><b>Sleeve</b> Ideal For Copper</p>				
		Part Number	Standard Pack	Tube	Pipe Thread	Price Per Piece
6002		100	1/8	-		
6003		100	3/16	-		
6004		100	1/4	-		
6005		100	5/16	-		
6006		100	3/8	-		
6008		50	1/2	-		
6010		50	5/8	-		
6012		50	3/4	-		
<p><b>61</b></p> 		<p><b>Compression Nut</b></p>				
		Part Number	Standard Pack	Tube	Pipe Thread	Price Per Piece
		6102	50	1/8	-	
	6103	50	3/16	-		
	6104	50	1/4	-		
	6105	50	5/16	-		
	6106	50	3/8	-		
	6108	25	1/2	-		
	6110	15	5/8	-		
	6112	15	3/4	-		
	6116	1	1"	-		

# Compression Fittings

<b>Hose Insert</b>					<b>261</b>
Provides Support For Plastic Tubes					
Part Number	Standard Pack	Tube OD	Tube ID	Price Per Piece	
26103	50	3/16	3.10mm		
26104	50	1/4	3.86mm		
26105	50	5/16	5.03mm		
26106	20	3/8	5.84mm		
26108	20	1/2	9.14mm		
26110	10	5/8	12.20mm		
<b>Double Union</b>					<b>62</b>
Supplied Complete With 60N Sleeves and 61 Nuts					
Part Number	Standard Pack	Tube	Pipe Thread	Price Per Piece	
6202	25	1/8	-		
6203	25	3/16	-		
6204	25	1/4	-		
6205	25	5/16	-		
6206	25	3/8	-		
6208	10	1/2	-		
6210	10	5/8	-		
6212	5	3/4	-		
<b>Reducing Union</b>					<b>62R</b>
Supplied Complete With 60N Sleeves and 61 Nuts					
Part Number	Standard Pack	Tube	Tube	Price Per Piece	
62R0403	20	1/4	42430		
62R0504	20	5/16	38808		
62R0604	20	3/8	38808		
62R0605	20	3/8	42491		
62R0804	-	1/2	38808		
62R0806	5	1/2	38932		
62R1006	-	5/8	38932		

**COMP**

# Compression Fittings

**COMP**

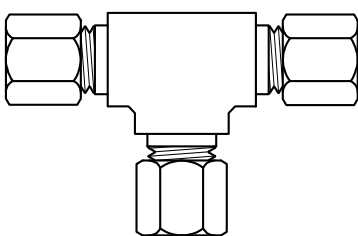
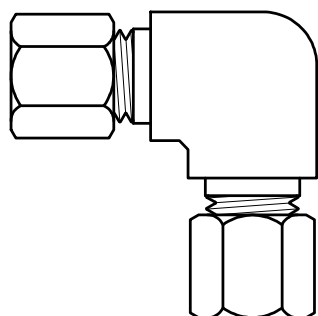
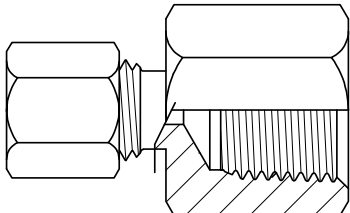
<h2>64</h2> 	<h3>Union Tee</h3> <p>Supplied Complete With 60N Sleeves and 61 Nuts.</p> <table border="1"> <thead> <tr> <th>Part Number</th> <th>Standard Pack</th> <th>Tube</th> <th>Pipe Thread</th> <th>Price Per Piece</th> </tr> </thead> <tbody> <tr><td>6402</td><td>20</td><td>1/8</td><td>-</td><td></td></tr> <tr><td>6403</td><td>10</td><td>3/16</td><td>-</td><td></td></tr> <tr><td>6404</td><td>10</td><td>1/4</td><td>-</td><td></td></tr> <tr><td>6405</td><td>10</td><td>5/16</td><td>-</td><td></td></tr> <tr><td>6406</td><td>10</td><td>3/8</td><td>-</td><td></td></tr> <tr><td>6408</td><td>10</td><td>1/2</td><td>-</td><td></td></tr> <tr><td>6410</td><td>5</td><td>5/8</td><td>-</td><td></td></tr> <tr><td>6412</td><td>-</td><td>3/4</td><td>-</td><td></td></tr> </tbody> </table>	Part Number	Standard Pack	Tube	Pipe Thread	Price Per Piece	6402	20	1/8	-		6403	10	3/16	-		6404	10	1/4	-		6405	10	5/16	-		6406	10	3/8	-		6408	10	1/2	-		6410	5	5/8	-		6412	-	3/4	-						
Part Number	Standard Pack	Tube	Pipe Thread	Price Per Piece																																															
6402	20	1/8	-																																																
6403	10	3/16	-																																																
6404	10	1/4	-																																																
6405	10	5/16	-																																																
6406	10	3/8	-																																																
6408	10	1/2	-																																																
6410	5	5/8	-																																																
6412	-	3/4	-																																																
<h2>65</h2> 	<h3>Union Elbow</h3> <p>Supplied Complete With 60N Sleeves and 61 Nuts.</p> <table border="1"> <thead> <tr> <th>Part Number</th> <th>Standard Pack</th> <th>Tube</th> <th>Pipe Thread</th> <th>Price Per Piece</th> </tr> </thead> <tbody> <tr><td>6502</td><td>20</td><td>1/8</td><td>-</td><td></td></tr> <tr><td>6503</td><td>20</td><td>3/16</td><td>-</td><td></td></tr> <tr><td>6504</td><td>20</td><td>1/4</td><td>-</td><td></td></tr> <tr><td>6505</td><td>20</td><td>5/16</td><td>-</td><td></td></tr> <tr><td>6506</td><td>10</td><td>3/8</td><td>-</td><td></td></tr> <tr><td>6508</td><td>10</td><td>1/2</td><td>-</td><td></td></tr> <tr><td>6510</td><td>-</td><td>5/8</td><td>-</td><td></td></tr> <tr><td>6512</td><td>-</td><td>3/4</td><td>-</td><td></td></tr> </tbody> </table>	Part Number	Standard Pack	Tube	Pipe Thread	Price Per Piece	6502	20	1/8	-		6503	20	3/16	-		6504	20	1/4	-		6505	20	5/16	-		6506	10	3/8	-		6508	10	1/2	-		6510	-	5/8	-		6512	-	3/4	-						
Part Number	Standard Pack	Tube	Pipe Thread	Price Per Piece																																															
6502	20	1/8	-																																																
6503	20	3/16	-																																																
6504	20	1/4	-																																																
6505	20	5/16	-																																																
6506	10	3/8	-																																																
6508	10	1/2	-																																																
6510	-	5/8	-																																																
6512	-	3/4	-																																																
<h2>66</h2> 	<h3>Female Connector</h3> <p>Supplied Complete With 60N Sleeves and 61 Nuts.</p> <table border="1"> <thead> <tr> <th>Part Number</th> <th>Standard Pack</th> <th>Tube</th> <th>Pipe Thread</th> <th>Price Per Piece</th> </tr> </thead> <tbody> <tr><td>660202</td><td>20</td><td>1/8</td><td>1/8 BSPP</td><td></td></tr> <tr><td>660302</td><td>20</td><td>3/16</td><td>1/8 BSPP</td><td></td></tr> <tr><td>660402</td><td>20</td><td>1/4</td><td>1/8 BSPP</td><td></td></tr> <tr><td>660404</td><td>20</td><td>1/4</td><td>1/4 BSPP</td><td></td></tr> <tr><td>660406</td><td>20</td><td>1/4</td><td>3/8 BSPP</td><td></td></tr> <tr><td>660408</td><td>10</td><td>1/4</td><td>1/2 BSPP</td><td></td></tr> <tr><td>660502</td><td>20</td><td>5/16</td><td>1/8 BSPP</td><td></td></tr> <tr><td>660504</td><td>20</td><td>5/16</td><td>1/4 BSPP</td><td></td></tr> <tr><td>660506</td><td>20</td><td>5/16</td><td>3/8 BSPP</td><td></td></tr> </tbody> </table> <p style="text-align: right;">Continued on next page...</p>	Part Number	Standard Pack	Tube	Pipe Thread	Price Per Piece	660202	20	1/8	1/8 BSPP		660302	20	3/16	1/8 BSPP		660402	20	1/4	1/8 BSPP		660404	20	1/4	1/4 BSPP		660406	20	1/4	3/8 BSPP		660408	10	1/4	1/2 BSPP		660502	20	5/16	1/8 BSPP		660504	20	5/16	1/4 BSPP		660506	20	5/16	3/8 BSPP	
Part Number	Standard Pack	Tube	Pipe Thread	Price Per Piece																																															
660202	20	1/8	1/8 BSPP																																																
660302	20	3/16	1/8 BSPP																																																
660402	20	1/4	1/8 BSPP																																																
660404	20	1/4	1/4 BSPP																																																
660406	20	1/4	3/8 BSPP																																																
660408	10	1/4	1/2 BSPP																																																
660502	20	5/16	1/8 BSPP																																																
660504	20	5/16	1/4 BSPP																																																
660506	20	5/16	3/8 BSPP																																																

# Compression Fittings

..Continued from previous page.

## Female Connector

66

Part Number	Standard Pack	Tube	Pipe Thread	Price Per Piece
660602	20	3/8	1/8 BSPP	
660604	20	3/8	1/4 BSPP	
660606	20	3/8	3/8 BSPP	
660608	20	3/8	1/2 BSPP	
660806	10	1/2	3/8 BSPP	
660808	10	1/2	1/2 BSPP	
661208	-	3/4	1/2 BSPP	
661212	-	3/4	3/4 BSPP	

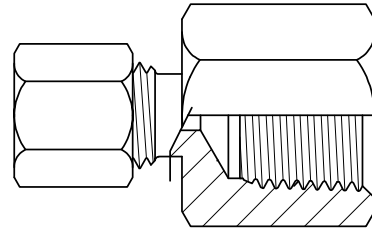

COMP

## Male Connector

68

Supplied Complete With 60N Sleeves and 61 Nuts

Part Number	Standard Pack	Tube	Pipe Thread	Price Per Piece
680202	20	1/8	1/8 BSPT	
680204	20	1/8	1/4 BSPT	
680302	20	3/16	1/8 BSPT	
680304	20	3/16	1/4 BSPT	
680402	25	1/4	1/8 BSPT	
680404	25	1/4	1/4 BSPT	
680406	20	1/4	3/8 BSPT	
680408	10	1/4	1/2 BSPT	
680412	10	1/4	3/4 BSPT	
680502	25	5/16	1/8 BSPT	
680504	25	5/16	1/4 BSPT	
680506	20	5/16	3/8 BSPT	
680508	10	5/16	1/2 BSPT	
680602	20	3/8	1/8 BSPT	
680604	25	3/8	1/4 BSPT	
680606	10	3/8	3/8 BSPT	
680608	20	3/8	1/2 BSPT	
680804	10	1/2	1/4 BSPT	
680806	20	1/2	3/8 BSPT	
680808	10	1/2	1/2 BSPT	
680812	10	1/2	3/4 BSPT	
681006	10	5/8	3/8 BSPT	
681008	10	5/8	1/2 BSPT	
681012	10	5/8	3/4 BSPT	
681204	-	3/4	1/4 BSPT	
681208	5	3/4	1/2 BSPT	
681212	5	3/4	3/4 BSPT	

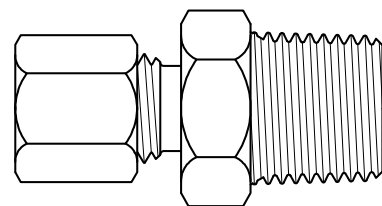

# Compression Fittings

**COMP**

**69**

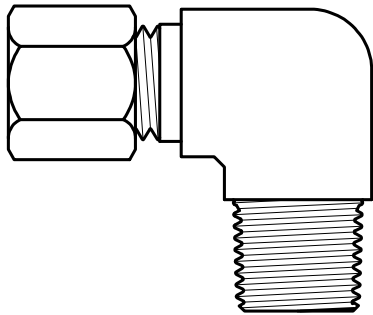

## Male Elbow

Supplied Complete With 60N Sleeves and 61 Nuts.

Part Number	Standard Pack	Tube	Pipe Thread	Price Per Piece
690202	20	1/8	1/8 BSPT	
690302	20	3/16	1/8 BSPT	
690402	20	1/4	1/8 BSPT	
690404	20	1/4	1/4 BSPT	
690406	20	1/4	3/8 BSPT	
690502	20	5/16	1/8 BSPT	
690504	20	5/16	1/4 BSPT	
690602	20	3/8	1/8 BSPT	
690604	20	3/8	1/4 BSPT	
690606	10	3/8	3/8 BSPT	
690608	10	3/8	1/2 BSPT	
690804	10	1/2	1/4 BSPT	
690806	10	1/2	3/8 BSPT	
690808	10	1/2	1/2 BSPT	
691006	5	5/8	3/8 BSPT	
691008	5	5/8	1/2 BSPT	
691208	5	3/4	1/2 BSPT	

**70**

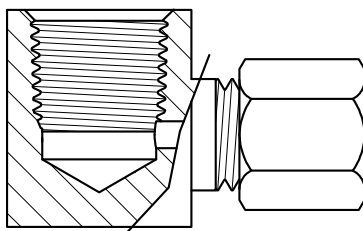

## Female Elbow

Supplied Complete With 60N Sleeves and 61 Nuts.

Part Number	Standard Pack	Tube	Pipe Thread	Price Per Piece
700202	20	1/8	1/8 BSPP	
700302	20	3/16	1/8 BSPP	
700402	20	1/4	1/8 BSPP	
700604	10	3/8	1/4 BSPP	
700806	10	1/2	3/8 BSPP	



# Compression Fittings

Union Male Run Tee					71
Supplied Complete With 60N Sleeves and 61 Nuts.					
Part Number	Standard Pack	Tube	Pipe Thread	Price Per Piece	
710202	10	1/8	1/8 BSPT		
710302	10	3/16	1/8 BSPT		
710402	10	1/4	1/8 BSPT		
710404	10	1/4	1/4 BSPT		
710502	10	5/16	1/8 BSPT		
710504	10	5/16	1/4 BSPT		
710604	10	3/8	1/4 BSPT		
710806	5	1/2	3/8 BSPT		
Union Male Branch Tee					72
Supplied Complete With 60N Sleeves and 61 Nuts					
Part Number	Standard Pack	Tube	Pipe Thread	Price Per Piece	
720202	20	1/8	1/8 BSPT		
720302	20	3/16	1/8 BSPT		
720402	10	1/4	1/8 BSPT		
720404	10	1/4	1/4 BSPT		
720502	10	5/16	1/8 BSPT		
720504	10	5/16	1/4 BSPT		
720604	10	3/8	1/4 BSPT		
720606	1	3/8	3/8 BSPT		
720804	1	1/2	1/4 BSPT		
720806	1	1/2	3/8 BSPT		
Male/Female Run Tee					76
Supplied Complete With 60N Sleeves and 61 Nuts					
Part Number	Standard Pack	Tube	Pipe Thread	Price Per Piece	
760202	10	1/8	1/8 BSPT		
760302	10	3/16	1/8 BSPT		
760402	10	1/4	1/8 BSPT		
760502	10	5/16	1/8 BSPT		
760604	10	3/8	1/4 BSPT		

**COMP**

# Metric Compression Fittings

COMP

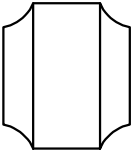
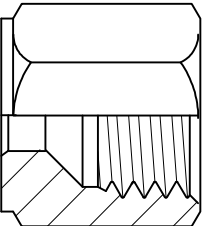
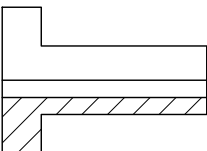
<p><b>M60N</b></p> 	<p align="center"><b>Metric Sleeve</b> For All Materials. Ideal For Nylon</p> <table border="1"> <thead> <tr> <th>Part Number</th> <th>Standard Pack</th> <th>Tube</th> <th>Pipe Thread</th> <th>Price</th> </tr> </thead> <tbody> <tr><td>M60N04</td><td>50</td><td>4 mm</td><td>-</td><td></td></tr> <tr><td>M60N06</td><td>50</td><td>6 mm</td><td>-</td><td></td></tr> <tr><td>M60N08</td><td>50</td><td>8 mm</td><td>-</td><td></td></tr> <tr><td>M60N10</td><td>50</td><td>10 mm</td><td>-</td><td></td></tr> <tr><td>M60N12</td><td>20</td><td>12 mm</td><td>-</td><td></td></tr> <tr><td>M60N16</td><td>20</td><td>16 mm</td><td>-</td><td></td></tr> </tbody> </table>	Part Number	Standard Pack	Tube	Pipe Thread	Price	M60N04	50	4 mm	-		M60N06	50	6 mm	-		M60N08	50	8 mm	-		M60N10	50	10 mm	-		M60N12	20	12 mm	-		M60N16	20	16 mm	-	
Part Number	Standard Pack	Tube	Pipe Thread	Price																																
M60N04	50	4 mm	-																																	
M60N06	50	6 mm	-																																	
M60N08	50	8 mm	-																																	
M60N10	50	10 mm	-																																	
M60N12	20	12 mm	-																																	
M60N16	20	16 mm	-																																	
<p><b>M61</b></p> 	<p align="center"><b>Metric Compression Nut</b></p> <table border="1"> <thead> <tr> <th>Part Number</th> <th>Standard Pack</th> <th>Tube</th> <th>Pipe Thread</th> <th>Price</th> </tr> </thead> <tbody> <tr><td>M6104</td><td>20</td><td>4 mm</td><td>-</td><td></td></tr> <tr><td>M6106</td><td>20</td><td>6 mm</td><td>-</td><td></td></tr> <tr><td>M6108</td><td>20</td><td>8 mm</td><td>-</td><td></td></tr> <tr><td>M6110</td><td>20</td><td>10 mm</td><td>-</td><td></td></tr> <tr><td>M6112</td><td>20</td><td>12 mm</td><td>-</td><td></td></tr> <tr><td>M6116</td><td>10</td><td>16 mm</td><td>-</td><td></td></tr> </tbody> </table>	Part Number	Standard Pack	Tube	Pipe Thread	Price	M6104	20	4 mm	-		M6106	20	6 mm	-		M6108	20	8 mm	-		M6110	20	10 mm	-		M6112	20	12 mm	-		M6116	10	16 mm	-	
Part Number	Standard Pack	Tube	Pipe Thread	Price																																
M6104	20	4 mm	-																																	
M6106	20	6 mm	-																																	
M6108	20	8 mm	-																																	
M6110	20	10 mm	-																																	
M6112	20	12 mm	-																																	
M6116	10	16 mm	-																																	
<p><b>M261</b></p> 	<p align="center"><b>Metric Hose Insert</b> Provides Support For Plastic Tubes.</p> <table border="1"> <thead> <tr> <th>Part Number</th> <th>Standard Pack</th> <th>Tube OD</th> <th>Tube ID</th> <th>Price</th> </tr> </thead> <tbody> <tr><td>M26104</td><td>50</td><td>4 mm</td><td>2.25 mm</td><td></td></tr> <tr><td>M26106</td><td>50</td><td>6 mm</td><td>3.50 mm</td><td></td></tr> <tr><td>M26108</td><td>50</td><td>8 mm</td><td>5.05 mm</td><td></td></tr> <tr><td>M26110</td><td>50</td><td>10 mm</td><td>6.35 mm</td><td></td></tr> <tr><td>M26112</td><td>50</td><td>12 mm</td><td>8.40 mm</td><td></td></tr> </tbody> </table>	Part Number	Standard Pack	Tube OD	Tube ID	Price	M26104	50	4 mm	2.25 mm		M26106	50	6 mm	3.50 mm		M26108	50	8 mm	5.05 mm		M26110	50	10 mm	6.35 mm		M26112	50	12 mm	8.40 mm						
Part Number	Standard Pack	Tube OD	Tube ID	Price																																
M26104	50	4 mm	2.25 mm																																	
M26106	50	6 mm	3.50 mm																																	
M26108	50	8 mm	5.05 mm																																	
M26110	50	10 mm	6.35 mm																																	
M26112	50	12 mm	8.40 mm																																	

# Metric Compression Fittings

**COMP**

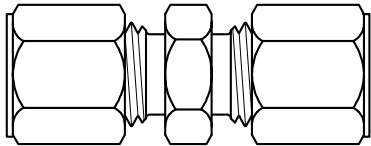
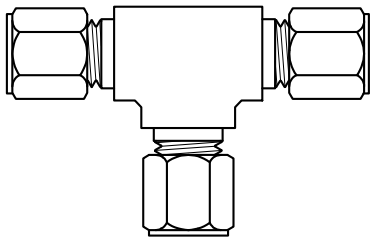
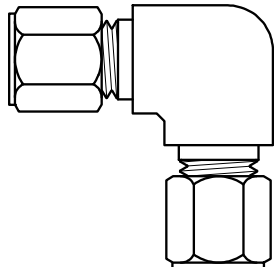
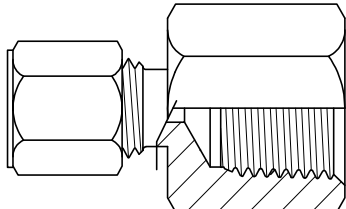
<p><b>Metric Double Union</b></p> <p>Supplied Complete With M60N Sleeves and M61 Nuts</p> <table border="1" style="width: 100%; border-collapse: collapse;"> <thead> <tr style="background-color: #ffff00;"> <th>Part Number</th> <th>Standard Pack</th> <th>Tube</th> <th>Pipe Thread</th> <th>Price</th> </tr> </thead> <tbody> <tr><td>M6204</td><td>10</td><td>4 mm</td><td>-</td><td></td></tr> <tr><td>M6206</td><td>10</td><td>6 mm</td><td>-</td><td></td></tr> <tr><td>M6208</td><td>10</td><td>8 mm</td><td>-</td><td></td></tr> <tr><td>M6210</td><td>10</td><td>10 mm</td><td>-</td><td></td></tr> <tr><td>M6212</td><td>5</td><td>12 mm</td><td>-</td><td></td></tr> <tr><td>M6216</td><td>5</td><td>16 mm</td><td>-</td><td></td></tr> </tbody> </table>	Part Number	Standard Pack	Tube	Pipe Thread	Price	M6204	10	4 mm	-		M6206	10	6 mm	-		M6208	10	8 mm	-		M6210	10	10 mm	-		M6212	5	12 mm	-		M6216	5	16 mm	-		<p><b>M62</b></p> 
Part Number	Standard Pack	Tube	Pipe Thread	Price																																
M6204	10	4 mm	-																																	
M6206	10	6 mm	-																																	
M6208	10	8 mm	-																																	
M6210	10	10 mm	-																																	
M6212	5	12 mm	-																																	
M6216	5	16 mm	-																																	
<p><b>Metric Union Tee</b></p> <p>Supplied Complete With M60N Sleeves and M61 Nuts</p> <table border="1" style="width: 100%; border-collapse: collapse;"> <thead> <tr style="background-color: #ffff00;"> <th>Part Number</th> <th>Standard Pack</th> <th>Tube</th> <th>Pipe Thread</th> <th>Price</th> </tr> </thead> <tbody> <tr><td>M6404</td><td>1</td><td>4 mm</td><td>-</td><td></td></tr> <tr><td>M6406</td><td>1</td><td>6 mm</td><td>-</td><td></td></tr> <tr><td>M6408</td><td>1</td><td>8 mm</td><td>-</td><td></td></tr> <tr><td>M6410</td><td>1</td><td>10 mm</td><td>-</td><td></td></tr> <tr><td>M6412</td><td>1</td><td>12 mm</td><td>-</td><td></td></tr> <tr><td>M6416</td><td>1</td><td>16 mm</td><td>-</td><td></td></tr> </tbody> </table>	Part Number	Standard Pack	Tube	Pipe Thread	Price	M6404	1	4 mm	-		M6406	1	6 mm	-		M6408	1	8 mm	-		M6410	1	10 mm	-		M6412	1	12 mm	-		M6416	1	16 mm	-		<p><b>M64</b></p> 
Part Number	Standard Pack	Tube	Pipe Thread	Price																																
M6404	1	4 mm	-																																	
M6406	1	6 mm	-																																	
M6408	1	8 mm	-																																	
M6410	1	10 mm	-																																	
M6412	1	12 mm	-																																	
M6416	1	16 mm	-																																	
<p><b>Metric Union Elbow</b></p> <p>Supplied Complete With M60N Sleeves and M61 Nuts</p> <table border="1" style="width: 100%; border-collapse: collapse;"> <thead> <tr style="background-color: #ffff00;"> <th>Part Number</th> <th>Standard Pack</th> <th>Tube</th> <th>Pipe Thread</th> <th>Price</th> </tr> </thead> <tbody> <tr><td>M6504</td><td>1</td><td>4 mm</td><td>-</td><td></td></tr> <tr><td>M6506</td><td>1</td><td>6 mm</td><td>-</td><td></td></tr> <tr><td>M6508</td><td>1</td><td>8 mm</td><td>-</td><td></td></tr> <tr><td>M6510</td><td>1</td><td>10 mm</td><td>-</td><td></td></tr> <tr><td>M6512</td><td>1</td><td>12 mm</td><td>-</td><td></td></tr> <tr><td>M6516</td><td>1</td><td>16 mm</td><td>-</td><td></td></tr> </tbody> </table>	Part Number	Standard Pack	Tube	Pipe Thread	Price	M6504	1	4 mm	-		M6506	1	6 mm	-		M6508	1	8 mm	-		M6510	1	10 mm	-		M6512	1	12 mm	-		M6516	1	16 mm	-		<p><b>M65</b></p> 
Part Number	Standard Pack	Tube	Pipe Thread	Price																																
M6504	1	4 mm	-																																	
M6506	1	6 mm	-																																	
M6508	1	8 mm	-																																	
M6510	1	10 mm	-																																	
M6512	1	12 mm	-																																	
M6516	1	16 mm	-																																	
<p><b>Metric Female Connector</b></p> <p>Supplied Complete With M60N Sleeves and M61 Nuts</p> <table border="1" style="width: 100%; border-collapse: collapse;"> <thead> <tr style="background-color: #ffff00;"> <th>Part Number</th> <th>Standard Pack</th> <th>Tube</th> <th>Pipe Thread</th> <th>Price</th> </tr> </thead> <tbody> <tr><td>M660604</td><td>1</td><td>6 mm</td><td>1/4 BSPP</td><td></td></tr> <tr><td>M660804</td><td>1</td><td>8 mm</td><td>1/4 BSPP</td><td></td></tr> <tr><td>M661004</td><td>1</td><td>10 mm</td><td>1/4 BSPP</td><td></td></tr> <tr><td>M661006</td><td>1</td><td>10 mm</td><td>3/8 BSPP</td><td></td></tr> <tr><td>M661208</td><td>1</td><td>12 mm</td><td>1/2 BSPP</td><td></td></tr> </tbody> </table>	Part Number	Standard Pack	Tube	Pipe Thread	Price	M660604	1	6 mm	1/4 BSPP		M660804	1	8 mm	1/4 BSPP		M661004	1	10 mm	1/4 BSPP		M661006	1	10 mm	3/8 BSPP		M661208	1	12 mm	1/2 BSPP		<p><b>M66</b></p> 					
Part Number	Standard Pack	Tube	Pipe Thread	Price																																
M660604	1	6 mm	1/4 BSPP																																	
M660804	1	8 mm	1/4 BSPP																																	
M661004	1	10 mm	1/4 BSPP																																	
M661006	1	10 mm	3/8 BSPP																																	
M661208	1	12 mm	1/2 BSPP																																	

# Metric Compression Fittings

## M68

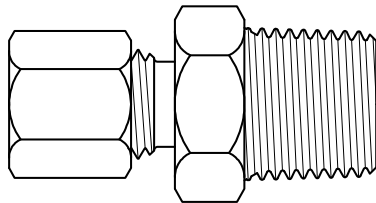

### Metric Male Connector

Supplied Complete With M60N Sleeves and M61 Nuts.

Part Number	Standard Pack	Tube	Pipe Thread	Price
M680402	10	4 mm	1/8 BSPT	
M680404	10	4 mm	1/4 BSPT	
M680602	10	6 mm	1/8 BSPT	
M680604	10	6 mm	1/4 BSPT	
M680606	10	6 mm	3/8 BSPT	
M680802	10	8 mm	1/8 BSPT	
M680804	10	8 mm	1/4 BSPT	
M680806	10	8 mm	3/8 BSPT	
M680808	10	8 mm	1/2 BSPT	
M681002	10	10 mm	1/8 BSPT	
M681004	10	10 mm	1/4 BSPT	
M681006	10	10 mm	3/8 BSPT	
M681008	10	10 mm	1/2 BSPT	
M681204	10	12 mm	1/4 BSPT	
M681206	10	12 mm	3/8 BSPT	
M681208	10	12 mm	1/2 BSPT	
M681606	5	16 mm	3/9 BSPT	
M681608	5	16 mm	1/2 BSPT	

## M69

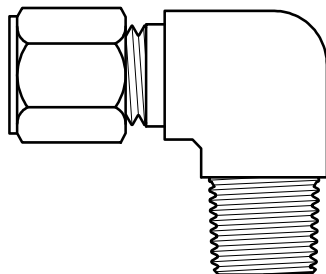

### Metric Male Elbow

Supplied Complete With M60N Sleeves and M61 Nuts.

Part Number	Standard Pack	Tube	Pipe Thread	Price
M690402	10	4 mm	1/8 BSPT	
M690404	10	4 mm	1/4 BSPT	
M690602	10	6 mm	1/8 BSPT	
M690604	10	6 mm	1/4 BSPT	
M690606	10	6 mm	3/8 BSPT	
M690802	10	8 mm	1/8 BSPT	
M690804	10	8 mm	1/4 BSPT	
M690806	10	8 mm	3/8 BSPT	
M691002	10	10 mm	1/8 BSPT	
M691004	10	10 mm	1/4 BSPT	
M691006	10	10 mm	3/8 BSPT	
M691204	5	12 mm	1/4 BSPT	
M691206	5	12 mm	3/8 BSPT	
M691208	5	12 mm	1/2 BSPT	

COMP

# Pipe Fittings

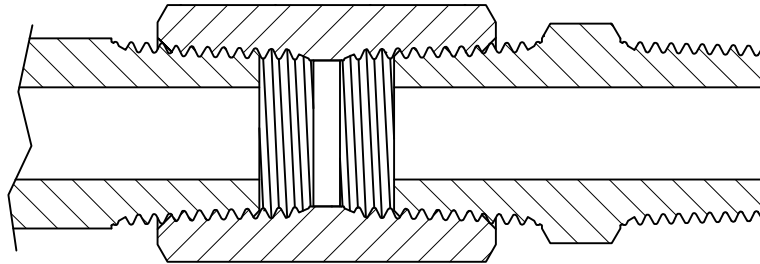

Standard TITON Pipe Fittings are manufactured with female R Series and male BSPT threads in accordance with AS1772. These robust fittings are available in a comprehensive range of sizes ranging from 1/8" to 1". They are manufactured from high quality DZR brass alloy. Some fittings are available with NPT threads. Please contact Titon for stock availability.

## ADVANTAGES

Very easy to assemble. No special tools or extra parts are necessary. May be assembled/disassembled numerous times.

## APPLICATIONS

May be used with copper, steel, or brass pipe. Install where medium to high pressures are encountered. Pipe Fittings provide good resistance to vibration. Ideal for use in pneumatic and hydraulic control equipment.

## WORKING PRESSURES

TITON Pipe Fittings are able to withstand high pressures, use the table below as a guideline.

## SPECIAL SIZES

Other threads/sizes not specified are available upon request.

## ASSEMBLY

- I. Use pipe sealing compound.
- II. Tighten 1½ to 2½ turns past hand tight.

Thread Size	Hydraulic kPa [PSI]	Pneumatic kPa [PSI]
1/8	13750 [2000]	3500 [500]
1/4	13750 [2000]	3500 [500]
3/8	13750 [2000]	2750 [400]
1/2	10400 [1500]	2750 [400]
3/4	7000 [1020]	2000 [290]
1"	4000 [580]	1250 [180]

# Pipe Fittings

## 3133

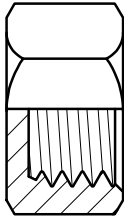

### Cap

Part Number	Standard Pack	Tube	Pipe Thread	Price Per Piece
313302	10	-	1/8 BSPP	
313304	10	-	1/4 BSPP	
313306	10	-	3/8 BSPP	
313308	10	-	1/2 BSPP	

## 3152

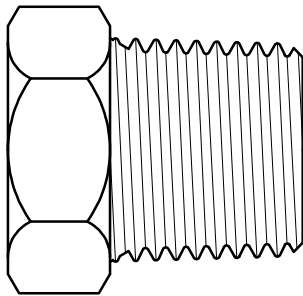

### Hex Plug

Available In Hollow and Solid Configurations.

Part Number	Standard Pack	Tube	Pipe Thread	Price Per Piece
315204	50	-	1/4 BSPT	
315206	50	-	3/8 BSPT	
315208	20	-	1/2 BSPT	
315212	10	-	3/4 BSPT	
315216	10	-	1" BSPT	

Parts Listed Above Are Hollow, Parts Listed Below Are Solid

315202S	10	-	1/8 BSPT	
315204S	10	-	1/4 BSPT	
315206S	10	-	3/8 BSPT	
315208S	10	-	1/2 BSPT	
315212S	10	-	3/4 BSPT	
315216S	10	-	1" BSPT	

## 3200

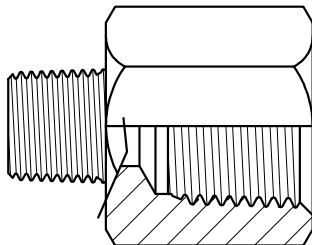

### Male To Female Adaptor

Part Number	Standard Pack	Pipe Thread (Female)	Pipe Thread (Male)	Price Per Piece
32000202	25	1/8 BSPP	1/8 BSPT	
32000402	25	1/4 BSPP	1/8 BSPT	
32000404	20	1/4 BSPP	1/4 BSPT	
32000602	20	3/8 BSPP	1/8 BSPT	
32000604	10	3/8 BSPP	1/4 BSPT	
32000606	10	3/8 BSPP	3/8 BSPT	
32000804	10	1/2 BSPP	1/4 BSPT	
32000806	10	1/2 BSPP	3/8 BSPT	
32000808	10	1/2 BSPP	1/2 BSPT	
32001204	5	3/4 BSPP	1/4 BSPT	
32001206	5	3/4 BSPP	3/8 BSPT	
32001208	5	3/4 BSPP	1/2 BSPT	
32001608	1	1" BSPT	1/2 BSPT	

# Pipe Fittings

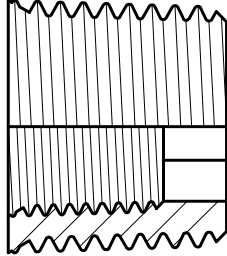
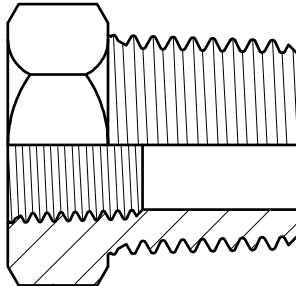
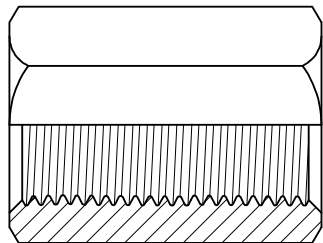
Flush Mount Reducing Bush					3223
Internal Hex Drive					
Part Number	Standard Pack	Pipe Thread (Female)	Pipe Thread (Male)	Price Per Piece	
32230402	20	1/8 BSPP	1/4 BSPT		
32230604	15	1/4 BSPP	3/8 BSPT		
32230806	10	3/8 BSPP	1/2 BSPT		
					
Reducing Bush					
Part Number	Standard Pack	Pipe Thread (Female)	Pipe Thread (Male)	Price Per Piece	
32240402	50	1/8 BSPP	1/4 BSPT		
32240602	50	1/8 BSPP	3/8 BSPT		
32240604	50	1/4 BSPP	3/8 BSPT		
32240802	20	1/8 BSPP	1/2 BSPT		
32240804	20	1/4 BSPP	1/2 BSPT		
32240806	20	3/8 BSPP	1/2 BSPT		
32241202	20	1/8 BSPP	3/4 BSPT		
32241204	20	1/4 BSPP	3/4 BSPT		
32241206	20	3/8 BSPP	3/4 BSPT		
32241208	20	1/2 BSPP	3/4 BSPT		
32241606	1	3/8 BSPP	1" BSPT		
32241608	1	1/2 BSPP	1" BSPT		
32241612	1	3/4 BSPP	1" BSPT		
					
Hex Socket					
Part Number	Standard Pack	Tube	Pipe Thread	Price Per Piece	
330002	50	-	1/8 BSPP		
330004	25	-	1/4 BSPP		
330006	20	-	3/8 BSPP		
330008	10	-	1/2 BSPP		
330012	5	-	3/4 BSPP		
330016	5	-	1" BSPP		
					

P  
I  
P  
E

# Pipe Fittings

## 3304

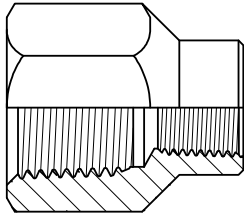

### Reducing Socket

Part Number	Standard Pack	Pipe Thread	Pipe Thread	Price Per Piece
33040402	20	1/4 BSPP	1/8 BSPP	
33040602	20	3/8 BSPP	1/8 BSPP	
33040604	20	3/8 BSPP	1/4 BSPP	
33040802	10	1/2 BSPP	1/8 BSPP	
33040804	10	1/2 BSPP	1/4 BSPP	
33040806	10	1/2 BSPP	3/8 BSPP	
33041206	10	3/4 BSPP	3/8 BSPP	
33041208	10	3/4 BSPP	1/2 BSPP	
33041612	1	1" BSPP	3/4 BSPP	

## 3324

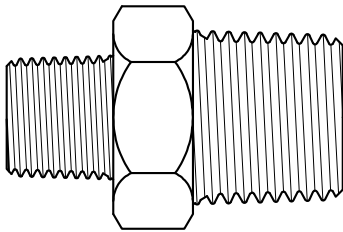

### Reducing Nipple

Part Number	Standard Pack	Pipe Thread	Pipe Thread	Price Per Piece
33240402	25	1/4 BSPT	1/8 BSPT	
33240602	25	3/8 BSPT	1/8 BSPT	
33240604	25	3/8 BSPT	1/4 BSPT	
33240802	25	1/2 BSPT	1/8 BSPT	
33240804	25	1/2 BSPT	1/4 BSPT	
33240806	25	1/2 BSPT	3/8 BSPT	
33241204	10	3/4 BSPT	1/4 BSPT	
33241206	10	3/4 BSPT	3/8 BSPT	
33241208	10	3/4 BSPT	1/2 BSPT	
33241608	1	1" BSPT	1/2 BSPT	
33241612	1	1" BSPT	3/4 BSPT	

## 3325

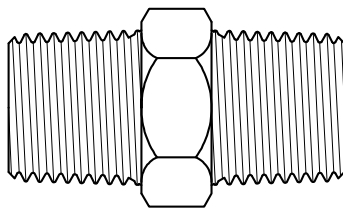

### Hex Nipple

Part Number	Standard Pack	Tube	Pipe Thread	Price Per Piece
332502	25	-	1/8 BSPT	
332504	25	-	1/4 BSPT	
332506	25	-	3/8 BSPT	
332508	10	-	1/2 BSPT	
332512	5	-	3/4 BSPT	
332516	1	-	1" BSPT	

P  
I  
P  
E

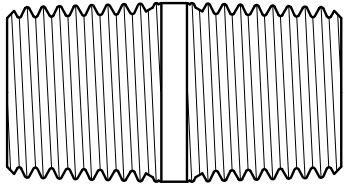

# Pipe Fittings

Barrel Nipple					<div style="text-align: right; font-size: 2em; font-weight: bold;">3326</div> 
Part Number	Standard Pack	Tube	Pipe Thread	Price Per Piece	
332602	25	-	1/8 BSPT		
332604	25	-	1/4 BSPT		
332606	25	-	3/8 BSPT		
332608	10	-	1/2 BSPT		
332612	5	-	3/4 BSPT		

Long Barrel Nipple					<div style="text-align: right; font-size: 2em; font-weight: bold;">3327</div> 
Part Number	Standard Pack	Pipe Thread	Length (Inches)	Price Per Piece	
3327021.5	25	1/8 BSPT	1.5		
3327022	25	1/8 BSPT	2		
3327022.5	25	1/8 BSPT	2.5		
3327023	25	1/8 BSPT	3		
3327041.5	25	1/4 BSPT	1.5		
3327042	25	1/4 BSPT	2		
3327042.5	25	1/4 BSPT	2.5		
3327043	25	1/4 BSPT	3		
3327061.5	25	3/8 BSPT	1.5		
3327062	25	3/8 BSPT	2		
3327062.5	25	3/8 BSPT	2.5		
3327063	20	3/8 BSPT	3		
3327082	15	1/2 BSPT	2		
3327082.5	10	1/2 BSPT	2.5		
3327083	10	1/2 BSPT	3		

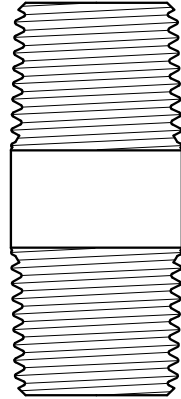
Male To Female 90° Elbow					<div style="text-align: right; font-size: 2em; font-weight: bold;">3400</div> 
Part Number	Standard Pack	Pipe Thread (Female)	Pipe Thread (Male)	Price Per Piece	
340002	25	1/8 BSPP	1/8 BSPT		
340004	20	1/4 BSPP	1/4 BSPT		
340006	10	3/8 BSPP	3/8 BSPT		
340008	10	1/2 BSPP	1/2 BSPT		

See Next Page For 45° Elbows

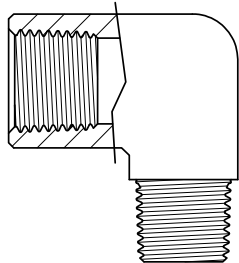
P  
I  
P  
E

# Pipe Fittings

## 340045

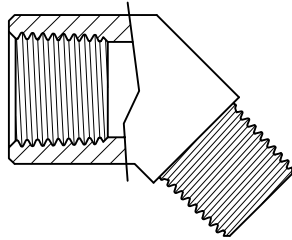

### Male To Female 45° Elbow

Part Number	Standard Pack	Pipe Thread (Female)	Pipe Thread (Male)	Price Per Piece
34004502	5	1/8 BSPP	1/8 BSPT	
34004504	5	1/4 BSPP	1/4 BSPT	
34004506	5	3/8 BSPP	3/8 BSPT	
34004508	5	1/2 BSPP	1/2 BSPT	

See Previous Page For 90° Elbows.

## 3500

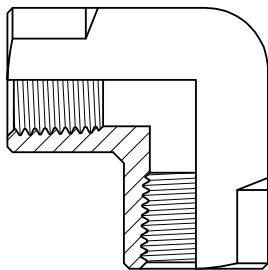

### Female 90° Elbow

Part Number	Standard Pack	Tube	Pipe Thread	Price Per Piece
350002	10	-	1/8 BSPP	
350004	10	-	1/4 BSPP	
350006	10	-	3/8 BSPP	
350008	10	-	1/2 BSPP	

### Female 45° Elbow

Part Number	Standard Pack	Tube	Pipe Thread	Price Per Piece
35004502	10	-	1/8 BSPP	
35004504	10	-	1/4 BSPP	
35004506	10	-	3/8 BSPP	

## 3600

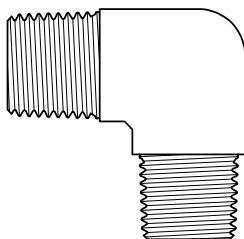

### Male 90° Elbow

Part Number	Standard Pack	Pipe Thread (Male)	Pipe Thread (Male)	Price Per Piece
36000202	10	1/8 BSPT	1/8 BSPT	
36000402	10	1/4 BSPT	1/8 BSPT	
36000404	10	1/4 BSPT	1/4 BSPT	
36000604	10	3/8 BSPT	1/4 BSPT	
36000606	10	3/8 BSPT	3/8 BSPT	
36000806	10	1/2 BSPT	3/8 BSPT	
36000808	10	1/2 BSPT	1/2 BSPT	

PIPE

# Pipe Fittings

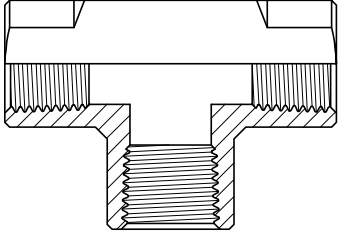
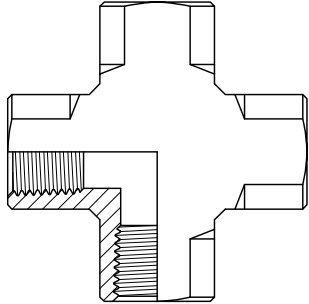
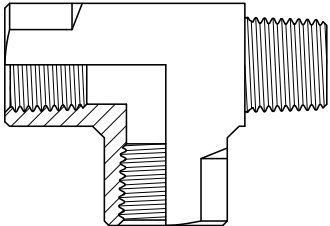
Female Tee					3700	
Part Number	Standard Pack	Tube	Pipe Thread (Female)	Price Per Piece		
370002	10	-	1/8 BSPP			
370004	10	-	1/4 BSPP			
370006	10	-	3/8 BSPP			
370008	10	-	1/2 BSPP			
Female Cross					3900	
Part Number	Standard Pack	Tube	Pipe Thread (Female)	Price Per Piece		
390002	10	-	1/8 BSPP			
390004	10	-	1/4 BSPP			
390006	10	-	3/8 BSPP			
390008	10	-	1/2 BSPP			
Male Run/Female Tee					4000	
Part Number	Standard Pack	Pipe Thread (Male)	Pipe Thread (Female)	Price Per Piece		
400002	10	1/8 BSPT	1/8 BSPT			
400004	10	1/4 BSPT	1/4 BSPT			
400006	10	3/8 BSPT	3/8 BSPT			
400008	-	1/2 BSPT	1/2 BSPT			

**P  
I  
P  
E**

## Metric Pipe Fittings

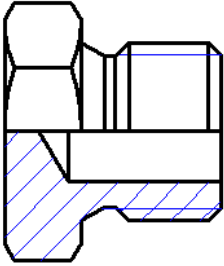
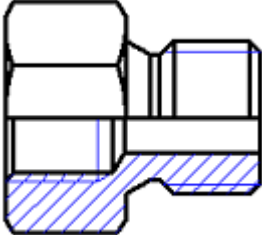
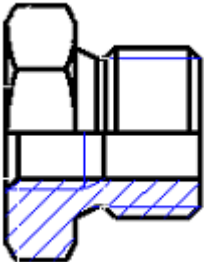
<p><b>3152M</b></p> 	<p style="text-align: center;"><b>Metric Hex Plug</b></p> <table border="1"> <thead> <tr style="background-color: #ffffcc;"> <th>Part Number</th> <th>Standard Pack</th> <th>Tube</th> <th>Pipe Thread</th> <th>Price Per Piece</th> </tr> </thead> <tbody> <tr><td>3152M12</td><td></td><td>-</td><td>M12x1.5</td><td></td></tr> <tr><td>3152M14</td><td></td><td>-</td><td>M14x1.5</td><td></td></tr> <tr><td>3152M16</td><td></td><td>-</td><td>M16x1.5</td><td></td></tr> <tr><td>3152M18</td><td></td><td>-</td><td>M18x1.5</td><td></td></tr> <tr><td>3152M20</td><td></td><td>-</td><td>M20x1.5</td><td></td></tr> <tr><td>3152M22</td><td></td><td>-</td><td>M22x1.5</td><td></td></tr> <tr><td>3152M24</td><td></td><td>-</td><td>M24x2</td><td></td></tr> </tbody> </table>	Part Number	Standard Pack	Tube	Pipe Thread	Price Per Piece	3152M12		-	M12x1.5		3152M14		-	M14x1.5		3152M16		-	M16x1.5		3152M18		-	M18x1.5		3152M20		-	M20x1.5		3152M22		-	M22x1.5		3152M24		-	M24x2	
Part Number	Standard Pack	Tube	Pipe Thread	Price Per Piece																																					
3152M12		-	M12x1.5																																						
3152M14		-	M14x1.5																																						
3152M16		-	M16x1.5																																						
3152M18		-	M18x1.5																																						
3152M20		-	M20x1.5																																						
3152M22		-	M22x1.5																																						
3152M24		-	M24x2																																						
<p><b>3200M</b></p> 	<p style="text-align: center;"><b>Male To Female Adaptor</b></p> <table border="1"> <thead> <tr style="background-color: #ffffcc;"> <th>Part Number</th> <th>Standard Pack</th> <th>Pipe Thread (Female)</th> <th>Pipe Thread (Male)</th> <th>Price Per Piece</th> </tr> </thead> <tbody> <tr><td>3200M1202</td><td></td><td>1/8"BSP</td><td>M12x1.5</td><td></td></tr> <tr><td>3200M1204</td><td></td><td>1/4"BSP</td><td>M12x1.5</td><td></td></tr> <tr><td>3200M1404</td><td></td><td>1/4"BSP</td><td>M14x1.5</td><td></td></tr> <tr><td>3200M1604</td><td></td><td>1/4"BSP</td><td>M16x1.5</td><td></td></tr> </tbody> </table>	Part Number	Standard Pack	Pipe Thread (Female)	Pipe Thread (Male)	Price Per Piece	3200M1202		1/8"BSP	M12x1.5		3200M1204		1/4"BSP	M12x1.5		3200M1404		1/4"BSP	M14x1.5		3200M1604		1/4"BSP	M16x1.5																
Part Number	Standard Pack	Pipe Thread (Female)	Pipe Thread (Male)	Price Per Piece																																					
3200M1202		1/8"BSP	M12x1.5																																						
3200M1204		1/4"BSP	M12x1.5																																						
3200M1404		1/4"BSP	M14x1.5																																						
3200M1604		1/4"BSP	M16x1.5																																						
<p><b>3224M</b></p> 	<p style="text-align: center;"><b>Reducing Bush</b></p> <table border="1"> <thead> <tr style="background-color: #ffffcc;"> <th>Part Number</th> <th>Standard Pack</th> <th>Pipe Thread (Female)</th> <th>Pipe Thread (Male)</th> <th>Price Per Piece</th> </tr> </thead> <tbody> <tr><td>3224M1402</td><td></td><td>1/8"BSP</td><td>M14x1.5</td><td></td></tr> <tr><td>3224M1602</td><td></td><td>1/8"BSP</td><td>M16x1.5</td><td></td></tr> <tr><td>3224M1804</td><td></td><td>1/4"BSP</td><td>M18x1.5</td><td></td></tr> <tr><td>3224M2004</td><td></td><td>1/4"BSP</td><td>M20x1.5</td><td></td></tr> <tr><td>3224M2204</td><td></td><td>1/4"BSP</td><td>M22x1.5</td><td></td></tr> <tr><td>3224M2206</td><td></td><td>3/8"BSP</td><td>M22x1.5</td><td></td></tr> <tr><td>3224M2406</td><td></td><td>3/8"BSP</td><td>M24x2</td><td></td></tr> </tbody> </table>	Part Number	Standard Pack	Pipe Thread (Female)	Pipe Thread (Male)	Price Per Piece	3224M1402		1/8"BSP	M14x1.5		3224M1602		1/8"BSP	M16x1.5		3224M1804		1/4"BSP	M18x1.5		3224M2004		1/4"BSP	M20x1.5		3224M2204		1/4"BSP	M22x1.5		3224M2206		3/8"BSP	M22x1.5		3224M2406		3/8"BSP	M24x2	
Part Number	Standard Pack	Pipe Thread (Female)	Pipe Thread (Male)	Price Per Piece																																					
3224M1402		1/8"BSP	M14x1.5																																						
3224M1602		1/8"BSP	M16x1.5																																						
3224M1804		1/4"BSP	M18x1.5																																						
3224M2004		1/4"BSP	M20x1.5																																						
3224M2204		1/4"BSP	M22x1.5																																						
3224M2206		3/8"BSP	M22x1.5																																						
3224M2406		3/8"BSP	M24x2																																						

# Metric Pipe Fittings

Hex Socket					3300M
Part Number	Standard Pack	Tube	Pipe Thread	Price Per Piece	
3300M12		-	M12x1.5		
3300M14		-	M14x1.5		
3300M16		-	M16x1.5		
3300M18		-	M18x1.5		
3300M20		-	M20x1.5		
3300M22		-	M22x1.5		
3300M24		-	M24x2		
Reducing Nipple					3324M
Part Number	Standard Pack	Pipe Thread	Pipe Thread	Price Per Piece	
3324M1202		1/8" BSPT	M12x1.5		
3324M1204		1/4" BSPT	M12x1.5		
3324M1404		1/4" BSPT	M14x1.5		
3324M1604		1/4" BSPT	M16x1.5		
3324M1804		1/4" BSPT	M18x1.5		
3324M2004		1/4" BSPT	M20x1.5		
3324M2006		3/8" BSPT	M20x1.5		
3324M2206		3/8" BSPT	M22x1.5		
3324M2406		3/8" BSPT	M24x2		
<p><b>PUT NPT AT END OF PART NO IF REQUIRING NPT THREADS (EG 3224xxxxNPT)</b></p>					

# NPT Pipe Fittings

PIPE

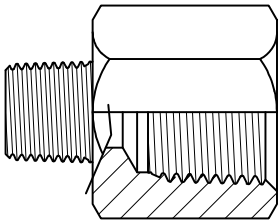
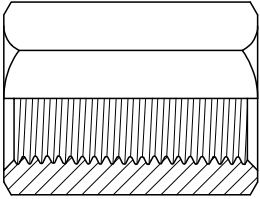
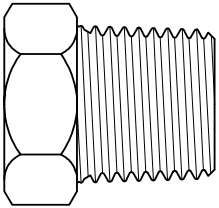
<p><b>NPT3200BSP</b></p> 	<p><b>Male BSP to Female NPT adaptor</b></p> <table border="1"> <thead> <tr> <th>Part Number</th> <th>Standard Pack</th> <th>Pipe Thread (Female)</th> <th>Pipe Thread (Male)</th> <th>Price Per Piece</th> </tr> </thead> <tbody> <tr> <td>NPT32000202BSP</td> <td>1</td> <td>1/8 NPT</td> <td>1/8 BSPT</td> <td></td> </tr> <tr> <td>NPT32000404BSP</td> <td>1</td> <td>1/4 NPT</td> <td>1/4 BSPT</td> <td></td> </tr> <tr> <td>NPT32000606BSP</td> <td>1</td> <td>3/8 NPT</td> <td>3/8 BSPT</td> <td></td> </tr> <tr> <td>NPT32000808BSP</td> <td>1</td> <td>1/2 NPT</td> <td>1/2 BSPT</td> <td></td> </tr> </tbody> </table>	Part Number	Standard Pack	Pipe Thread (Female)	Pipe Thread (Male)	Price Per Piece	NPT32000202BSP	1	1/8 NPT	1/8 BSPT		NPT32000404BSP	1	1/4 NPT	1/4 BSPT		NPT32000606BSP	1	3/8 NPT	3/8 BSPT		NPT32000808BSP	1	1/2 NPT	1/2 BSPT	
Part Number	Standard Pack	Pipe Thread (Female)	Pipe Thread (Male)	Price Per Piece																						
NPT32000202BSP	1	1/8 NPT	1/8 BSPT																							
NPT32000404BSP	1	1/4 NPT	1/4 BSPT																							
NPT32000606BSP	1	3/8 NPT	3/8 BSPT																							
NPT32000808BSP	1	1/2 NPT	1/2 BSPT																							
<p><b>3300NPT</b></p> 	<p><b>NPT Hex Socket</b></p> <table border="1"> <thead> <tr> <th>Part Number</th> <th>Standard Pack</th> <th>NPT Thread</th> <th>Price Per Piece</th> </tr> </thead> <tbody> <tr> <td>330002NPT</td> <td>1</td> <td>1/8</td> <td></td> </tr> <tr> <td>330004NPT</td> <td>1</td> <td>1/4</td> <td></td> </tr> <tr> <td>330006NPT</td> <td>1</td> <td>3/8</td> <td></td> </tr> </tbody> </table>	Part Number	Standard Pack	NPT Thread	Price Per Piece	330002NPT	1	1/8		330004NPT	1	1/4		330006NPT	1	3/8										
Part Number	Standard Pack	NPT Thread	Price Per Piece																							
330002NPT	1	1/8																								
330004NPT	1	1/4																								
330006NPT	1	3/8																								
<p><b>3152NPT</b></p> 	<p><b>NPT Hex Plug</b> Available In Hollow and Solid Configuration</p> <table border="1"> <thead> <tr> <th>Part Number</th> <th>Standard Pack</th> <th>NPT Thread</th> <th>Price Per Piece</th> </tr> </thead> <tbody> <tr> <td>315202NPT</td> <td>1</td> <td>1/8</td> <td></td> </tr> <tr> <td>315204NPT</td> <td>1</td> <td>1/4</td> <td></td> </tr> <tr> <td>315206NPT</td> <td>1</td> <td>3/8</td> <td></td> </tr> <tr> <td>315208NPT</td> <td>1</td> <td>1/2</td> <td></td> </tr> </tbody> </table>	Part Number	Standard Pack	NPT Thread	Price Per Piece	315202NPT	1	1/8		315204NPT	1	1/4		315206NPT	1	3/8		315208NPT	1	1/2						
Part Number	Standard Pack	NPT Thread	Price Per Piece																							
315202NPT	1	1/8																								
315204NPT	1	1/4																								
315206NPT	1	3/8																								
315208NPT	1	1/2																								

# Airline

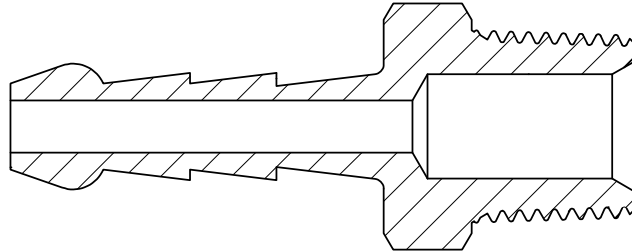

Using a special beaded barb design, TITON airline fittings provide unparalleled security against the hose pulling off the barb. They are available in sizes ranging from 3/16" to 1", and are manufactured from high quality DZR brass alloy.

## ADVANTAGES

Almost impossible to pull hose off. The 6° barbs give exceptional sealing properties, while the end bead provides a shoulder preventing any longitudinal movement of the hose. For added integrity two hose clips may be used.

## APPLICATIONS

Use with all rubber, plastic and other flexible hoses. Generally used where lower pressures (750 kPa) are encountered, although with the correct selection of hose and clamp, higher pressures can be accommodated.

## WORKING PRESSURES

TITON AirLine Fittings should be used where lower pressures exist (1000 kPa [145 PSI] maximum).

## ASSEMBLY

- I. Slide clamp onto hose.
- II. Push hose fully onto barb.
- III. Position clamp in the centre of the barb and tighten.

## SPECIAL SIZES

Other sizes not specified are available upon request.

# Airline

## 201

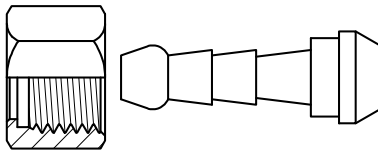

### Swivel Connector

Consists of Nut and Hose Barb

Part Number	Standard Pack	Tube	Pipe Thread	Price Per Piece
2010302	50	3/16	G 1/8	
2010304	50	3/16	G 1/4	
2010404	50	1/4	G 1/4	
2010406	50	1/4	G 3/8	
2010408	50	1/4	G 1/2	
2010504	50	5/16	G 1/4	
2010506	25	5/16	G 3/8	
2010508	25	5/16	G 1/2	
2010604	25	3/8	G 1/4	
2010606	25	3/8	G 3/8	
2010608	25	3/8	G 1/2	
2010806	25	1/2	G 3/8	
2010808	25	1/2	G 1/2	
2011212	5	3/4	G 3/4	
2011616	5	1"	G 1"	
201M1508	-	15mm	G 1/2	

## 202

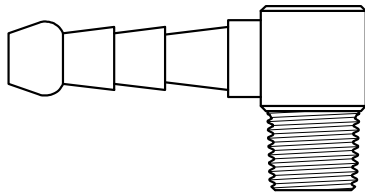

### Male Elbow

Part Number	Standard Pack	Tube	Pipe Thread	Price Per Piece
2020302	25	3/16	1/8 BSPT	
2020402	25	1/4	1/8 BSPT	
2020404	25	1/4	1/4 BSPT	
2020502	25	5/16	1/8 BSPT	
2020504	25	5/16	1/4 BSPT	
2020602	25	3/8	1/8 BSPT	
2020604	20	3/8	1/4 BSPT	
2020606	20	3/8	3/8 BSPT	
2020804	20	1/2	1/4 BSPT	
2020806	20	1/2	3/8 BSPT	
2020808	10	1/2	1/2 BSPT	
2021006	10	5/8	3/8 BSPT	
2021008	1	5/8	1/2 BSPT	
2021208	1	3/4	1/2 BSPT	
2021212	1	3/4	3/4 BSPT	
2021612	1	1"	3/4 BSPT	
2021616	1	1"	1" BSPT	

AIRLINE



# Airline

AirLine Tee					203
Part Number	Standard Pack	Tube	Pipe Thread	Price Per Piece	
20303	10	3/16	-		
20304	10	1/4	-		
20305	10	5/16	-		
20306	10	3/8	-		
20308	10	1/2	-		
20310	10	5/8	-		
20312	1	3/4	-		
20316	1	1"	-		
* ALSO AVAILABLE AS Y-PIECE CODE 06075-SIZE					204
AirLine Elbow					
Part Number	Standard Pack	Tube	Pipe Thread	Price Per Piece	
20403	25	3/16	-		
20404	25	1/4	-		
20405	20	5/16	-		
20406	20	3/8	-		
20408	20	1/2	-		
20410	10	5/8	-		
20412	1	3/4	-		
AirLine Joiner					205
Part Number	Standard Pack	Tube	Tube	Price Per Piece	
20503	25	3/16	-		
20504	25	1/4	-		
20505	20	5/16	-		
20506	20	3/8	-		
20508	20	1/2	-		
20510	10	5/8	-		
20512	10	3/4	-		
20516	10	1"	-		

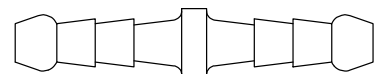
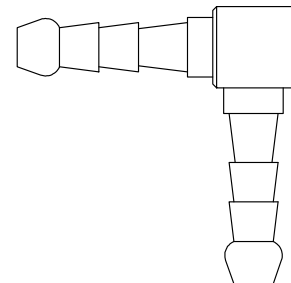
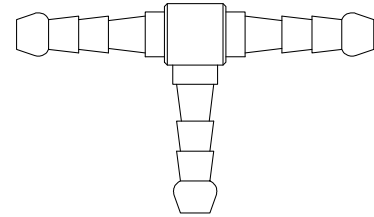

**A  
I  
R  
L  
I  
N  
E**

# Airline

## 206

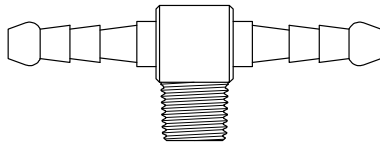

### Male Branch Tee

Part Number	Standard Pack	Tube	Pipe Thread	Price Per Piece
2060302	20	3/16	1/8 BSPT	
2060402	20	1/4	1/8 BSPT	
2060404	20	1/4	1/4 BSPT	
2060502	20	5/16	1/8 BSPT	
2060504	20	5/16	1/4 BSPT	
2060602	20	3/8	1/8 BSPT	
2060604	20	3/8	1/4 BSPT	
2060606	20	3/8	3/8 BSPT	
2060806	20	1/2	3/8 BSPT	
2060808	10	1/2	1/2 BSPT	
2061006	10	5/8	3/8 BSPT	
2061212	1	3/4	3/4 BSPT	

## 207

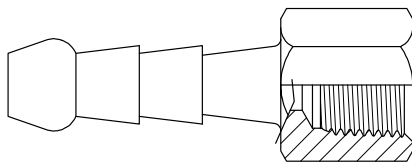

### Female Connector

Part Number	Standard Pack	Tube	Pipe Thread	Price Per Piece
2070302	50	3/16	1/8 BSPP	
2070304	50	3/16	1/4 BSPP	
2070402	50	1/4	1/8 BSPP	
2070404	25	1/4	1/4 BSPP	
2070406	25	1/4	3/8 BSPP	
2070408	25	1/4	1/2 BSPP	
2070502	25	5/16	1/8 BSPP	
2070504	25	5/16	1/4 BSPP	
2070506	25	5/16	3/8 BSPP	
2070602	25	3/8	1/8 BSPP	
2070604	20	3/8	1/4 BSPP	
2070606	20	3/8	3/8 BSPP	
2070608	20	3/8	1/2 BSPP	
2070804	20	1/2	1/4 BSPP	
2070806	20	1/2	3/8 BSPP	
2070808	10	1/2	1/2 BSPP	
2071006	10	5/8	3/8 BSPP	
2071212	-	3/4	3/4 BSPP	

AIRLINE

# Airline

## Male Connector

# 209

Part Number	Standard Pack	Tube	Pipe Thread	Price Per Piece
2090302	50	3/16	1/8 BSPT	
2090304	50	3/16	1/4 BSPT	
2090402	50	1/4	1/8 BSPT	
2090404	25	1/4	1/4 BSPT	
2090406	25	1/4	3/8 BSPT	
2090408	25	1/4	1/2 BSPT	
2090412	25	1/4	3/4 BSPT	
2090502	25	5/16	1/8 BSPT	
2090504	25	5/16	1/4 BSPT	
2090506	25	5/16	3/8 BSPT	
2090508	25	5/16	1/2 BSPT	
2090602	25	3/8	1/8 BSPT	
2090604	20	3/8	1/4 BSPT	
2090606	20	3/8	3/8 BSPT	
2090608	20	3/8	1/2 BSPT	
2090612	20	3/8	3/4 BSPT	
2090802	-	1/2	1/8 BSPT	
2090804	20	1/2	1/4 BSPT	
2090806	20	1/2	3/8 BSPT	
2090808	10	1/2	1/2 BSPT	
2090812	10	1/2	3/4 BSPT	
2091004	10	5/8	1/4 BSPT	
2091006	10	5/8	3/8 BSPT	
2091008	10	5/8	1/2 BSPT	
2091012	10	5/8	3/4 BSPT	
2091204	10	3/4	1/4 BSPT	
2091206	10	3/4	3/8 BSPT	
2091208	10	3/4	1/2 BSPT	
2091212	5	3/4	3/4 BSPT	
2091216	5	3/4	1" BSPT	
2091608	5	1"	1/2 BSPT	
2091612	5	1"	3/4 BSPT	
2091616	5	1"	1" BSPT	

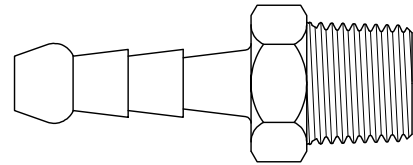

**A  
I  
R  
L  
I  
N  
E**

# Airline

## 209ST

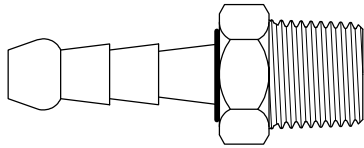

### Swivel Male Connector

Hose Is Free To Rotate Independently.

Part Number	Standard Pack	Tube	Pipe Thread	Price Per Piece
209ST0404	-	1/4	1/4 BSPT	
209ST0606	-	3/8	3/8 BSPT	
209ST0808	-	1/2	1/2 BSPT	
209ST1212	-	3/4	3/4 BSPT	

## 205R

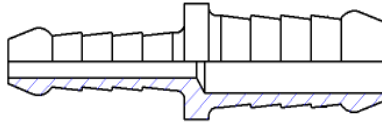

### Air Line Joiner

Part Number	Standard Pack	Tube	Pipe Thread	Price Per Piece
205R0403	25	1/4	3/16	
205R0504	20	5/16	1/4	
205R0604	20	3/8	1/4	
205R0605	20	3/8	5/16	
205R0805	20	1/2	5/16	
205R0806	20	1/2	3/8	
205R1006	10	5/8	3/8	
205R1008	10	5/8	1/2	
205R1208	10	3/4	1/2	
205R1210	10	3/4	5/8	
205R1612	10	1"	3/4	

AIRLINE

# Airbrake

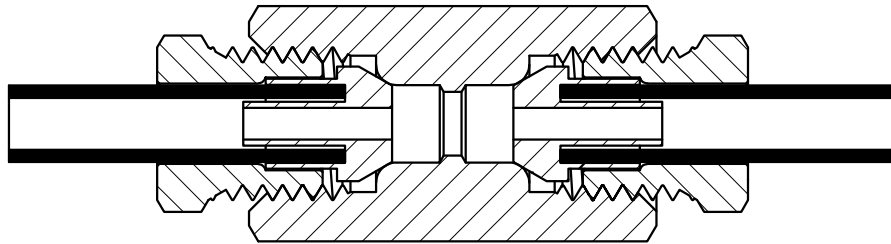

TITON Airbrake Fittings are based on a highly reliable proven design. They are available in sizes ranging from 1/8" to 1/2", and are manufactured from high quality DZR brass alloy.

#### **ADVANTAGES**

Simple to assemble/disassemble, no flaring or other special tools are required. Proven design.

#### **APPLICATIONS**

Used in heavy vehicle air braking systems, and where high reliability is required. Only recommended air brake tubing should be used with these fittings.

#### **WORKING PRESSURES**

TITON Airbrake Fittings should be used where pressures do not exceed 850 kPa [125 PSI]..

#### **ASSEMBLY**

- I. Slide nut, hex end first, onto plastic tube
- II. Push sleeve fully onto tube end.
- III. Screw into fitting body and tighten until a good seal is achieved. NOTE: Over-tightening may lead to premature failure of the fitting.

## Airbrake

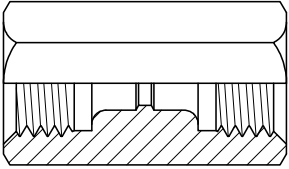
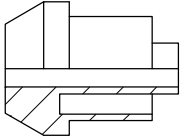
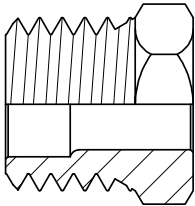
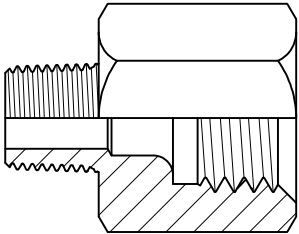
<h3>NF100</h3> 	<b>Airbrake Connector</b>					
	Part Number	Standard Pack	Tube	Thread	Price Per Piece	
	NF10003	20	1/8	3/8 UNF		
	NF10004	20	1/4	7/16 UNF		
	NF10005	20	5/16	1/2 UNF		
	NF10006	10	3/8	9/16 UNF		
NF10008	10	1/2	3/4 UNF			
<h3>NF103</h3> 	<b>Airbrake Sleeve</b>					
	Part Number	Standard Pack	Tube	Pipe Thread	Price Per Piece	
	NF10303	20	3/16	-		
	NF10304	20	1/4	-		
	NF10305	20	5/16	-		
	NF10306	10	3/8	-		
NF10308	10	1/2	-			
<h3>NF104</h3> 	<b>Airbrake Nut</b>					
	Part Number	Standard Pack	Tube	Thread	Price Per Piece	
	NF10403	20	3/16	3/8 UNF		
	NF10404	20	1/4	7/16 UNF		
	NF10405	20	5/16	1/2 UNF		
	NF10406	20	3/8	9/16 UNF		
NF10408	10	1/2	3/4 UNF			
<h3>NF105 BSPT BF105 NPT</h3> 	<b>Airbrake Adaptor</b>					
	Part Number	Std Pack	Tube	Thread	Pipe Thread	Price Per Piece
	NF1050302	20	3/16	3/8 UNF	1/8 BSPT	
	NF1050402	20	1/4	7/16 UNF	1/8 BSPT	
	NF1050404	20	1/4	7/16 UNF	1/4 BSPT	
	NF1050502	10	5/16	1/2 UNF	1/8 BSPT	
	NF1050504	10	5/16	1/2 UNF	1/4 BSPT	
	NF1050602	10	3/8	9/16 UNF	1/8 BSPT	
	NF1050604	10	3/8	9/16 UNF	1/4 BSPT	
	NF1050606	-	3/8	9/16 UNF	3/8 BSPT	
	NF1050804	5	1/2	3/4 UNF	1/4 BSPT	
NF1050806	5	1/2	3/4 UNF	3/8 BSPT		

# Airbrake

**A  
I  
R  
B  
R  
A  
K  
E**

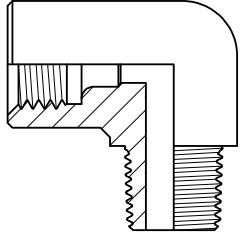
Airbrake Male Elbow						<h2>NF108</h2> 
Part Number	Standard Pack	Tube	Thread	Pipe Thread	Price Per Piece	
NF1080302	20	3/16	3/8 UNF	1/8 BSPT		
NF1080402	20	1/4	7/16 UNF	1/8 BSPT		
NF1080404	20	1/4	7/16 UNF	1/4 BSPT		
NF1080502	10	5/16	1/2 UNF	1/8 BSPT		
NF1080504	10	5/16	1/2 UNF	1/4 BSPT		
NF1080604	10	3/8	9/16 UNF	1/4 BSPT		
NF1080606	5	3/8	9/16 UNF	3/8 BSPT		
NF1080806	-	1/2	3/4 UNF	3/8 BSPT		

Airbrake Tee						<h2>NF110</h2> 
Part Number	Standard Pack	Tube	Thread	Price Per Piece		
NF11004	20	1/4	7/16 UNF			
NF11006	10	3/8	9/16 UNF			

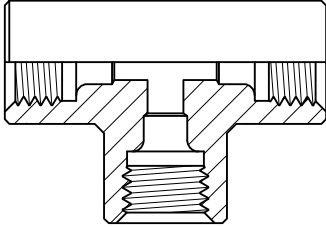
# Conversion Tables

Pressure		
PSI	kPa	BAR
100	689	6.89
200	1379	13.79
300	2068	20.68
400	2758	27.58
500	3447	34.47
600	4137	41.37
700	4826	48.26
800	5516	55.16
900	6205	62.05
1000	6895	68.95
1100	7584	75.84
1200	8274	82.74
1300	8963	89.63
1400	9653	96.53
1500	10342	103.4

Torque			
ftlb	Nm	Nm	ftlb
10	14	10	7
20	27	20	15
30	41	30	22
40	54	40	30
50	68	50	37
60	81	60	44
70	95	70	52
80	108	80	59
90	122	90	66
100	136	100	74
110	149	110	81
120	163	120	89
130	176	130	96
140	190	140	103
150	203	150	111
160	217	160	118
170	230	170	125
180	244	180	133
190	257	190	140
200	271	200	148
1 ftlb = 1.36 Nm		1 Nm = 0.738 ftlb	

### Threads Used on Brass Fittings

Tube Size	1/8	3/16	1/4	5/16	3/8	1/2	5/8	3/4
45° Flare	5/16-24	3/8-24	7/16-20	1/2-20	5/8-18	3/4-16	7/8-14	1" 1/16-14
	UNF	UNF	UNF	UNF	UNF	UNF	UNF	UN
Inverted Flare	5/16-28	3/8-24	7/16-24	1/2-20	5/8-18	3/4-18	7/8-18	1" 1/16-14
	UN	UNF	UNS	UNF	UNF	UNS	UNS	UN
Compression	5/16-24	3/8-24	7/16-24	1/2-24	9/16-24	11/16-20	13/16-18	1"-18
	UNF	UNF	UNS	UNS	UNEF	UN	UN	UNS



## ***Lever Taps & Cocks***



Lever Taps are precision manufactured and ground to ensure positive shut off action. They are available in sizes ranging from 1/8" to 1/2", and are manufactured from high quality grade brass alloy.

### **ADVANTAGES**

Lever Taps are compact and particularly suitable for confined spaces. Ground spindle and seat provide good metal to metal sealing properties.

### **APPLICATIONS**

Use where lower pressures exist and precise volume/pressure control is not required. Suitable for fuel, air and water.

### **WORKING PRESSURES**

Lever Taps should be used where pressures do not exceed 825 kPa [120 PSI].

# Lever Taps & Cocks

TAPS

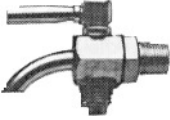
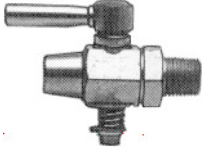
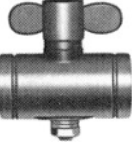
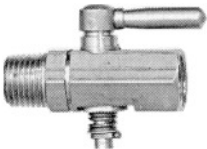
<p><b>DB1</b></p> 	<b>Bent Drain Cock</b>				
	Part Number	Standard Pack	Tube	Pipe Thread	Price Per Piece
	042064-B02	1	-	1/8 BSPT	
	042064-B04	1	-	1/4 BSPT	
	042064-CB04	1	-	1/4 BSPT	
042064-CB04 is Chrome Plated					
<p><b>DT3</b></p>  <p>IN LINE OFF</p>	<b>Drain Cock</b>				
	Part Number	Standard Pack	Tube	Pipe Thread	Price Per Piece
	042064-02	1	-	1/8 BSPT	
	042064-04	1	-	1/4 BSPT	
	042064-06	1	-	3/8 BSPT	
<p><b>104</b></p> 	<b>Female Lever Tap</b>				
	Part Number	Standard Pack	Tube	Pipe Thread	Price Per Piece
	042026-02	1	-	1/8 BSPP	
	042026-04	1	-	1/4 BSPP	
<p><b>404</b></p> 	<b>Male To Female Lever Tap</b>				
	Part Number	Standard Pack	Pipe Thread (Female)	Pipe Thread (Male)	Price Per Piece
	042072-02	1	1/8 BSPP	1/8 BSPT	
	042072-04	1	1/4 BSPP	1/4 BSPT	

## **Needle Valves**



Needle Valves allow precise control from fully off to fully on. Manufactured from high quality DZR brass alloy, Needle Valves are available in a variety of connections with sizes ranging from 1/8" to 3/8". In all needle valves Viton o'rings are used.

### **ADVANTAGES**

Precise control due to metal to metal seals and fine thread screw-down. Good pressure rating. Suitable for fuels, water and air.

### **APPLICATIONS**

Precision instrumentation, hydraulic control systems, and anywhere precise control is needed.

### **WORKING PRESSURES AND TEMPERATURE**

TITON Needle Valves should not be used where pressures exceed 3447 kPa [500 PSI] or 100°C.

### **ASSEMBLY**

Where possible, pressure side should be toward valve seat, not spindle.

***All Needle valves except NV41, NV43, NVP40 are approved for use with gas (A.G.A. Approval :4104).***

***Operating Temperature 0 to +90°***

# Needle Valves

## NV40



### 45° Flare Angle Needle Valve

Part Number	Standard Pack	Tube	Pipe Thread	Price Per Piece
041008-0402	1	1/4	1/8 BSPT	
041008-0502	1	5/16	1/8 BSPT	
041008-0604	1	3/8	1/4 BSPT	

## NV41



### Compression Angle Needle Valve

Part Number	Standard Pack	Tube	Pipe Thread	Price Per Piece
041005-0302	1	3/16	1/8 BSPT	
041005-0402	1	1/4	1/8 BSPT	
041005-0502	1	5/16	1/8 BSPT	
041005-0604	1	3/8	1/4 BSPT	

## NV43





### Compression Male Needle Valve

Part Number	Standard Pack	Tube	Pipe Thread	Price Per Piece
041003-0302	1	3/16	1/8 BSPT	
041003-0402	1	1/4	1/8 BSPT	

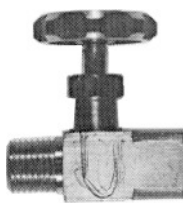

V  
A  
L  
V  
E  
S

# Needle Valves

<b>Barb Angle Needle Valve</b>					<b>NVP40</b>
<b>Part Number      Standard Pack      Tube      Pipe Thread      Price Per Piece</b>					
041606-0302	1	3/16	1/8 BSPT		
041606-0402	1	1/4	1/8 BSPT		
041606-0502	1	5/16	1/8 BSPT		
041606-0504	1	5/16	1/4 BSPT		
041606-0604	1	3/8	1/4 BSPT		
<b>Female Needle Valve</b>					<b>NV104</b>
<b>Part Number      Standard Pack      Tube      Pipe Thread      Price Per Piece</b>					
041026-02	1	-	1/8 BSPP		
041026-04	1	-	1/4 BSPP		
041026-06	1	-	3/8 BSPP		
<b>Male Needle Valve</b>					<b>NV105</b>
<b>Part Number      Standard Pack      Tube      Pipe Thread      Price Per Piece</b>					
041027-02	1	-	1/8 BSPT		
041027-04	1	-	1/4 BSPT		
<b>Male to Female Needle Valve</b>					<b>NV404</b>
<b>Part Number      Standard Pack      Pipe Thread (Female)      Pipe Thread (Male)      Price Per Piece</b>					
041072-02	1	1/8 BSPP	1/8 BSPT		
041072-04	1	1/4 BSPP	1/4 BSPT		

**V  
A  
L  
V  
E  
S**

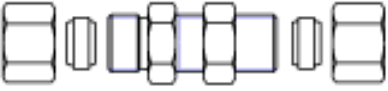
## Tube Connection Fittings

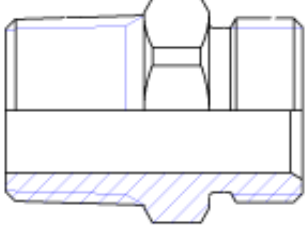
<p><b>01031</b></p> 	<p><b>No 31 Bulkhead Union</b></p>																																																																
<table border="1" style="width: 100%; border-collapse: collapse;"> <thead> <tr> <th style="text-align: left;">Part Number</th> <th style="text-align: center;">Standard Pack</th> <th style="text-align: center;">Tube</th> <th style="text-align: center;">Pipe Thread</th> <th style="text-align: center;">Price Per Piece</th> </tr> </thead> </table>						Part Number	Standard Pack	Tube	Pipe Thread	Price Per Piece																																																							
Part Number	Standard Pack	Tube	Pipe Thread	Price Per Piece																																																													
<table border="1" style="width: 100%; border-collapse: collapse;"> <tbody> <tr> <td style="width: 15%;">01031-04</td> <td style="width: 15%; text-align: center;">-</td> <td style="width: 15%; text-align: center;">1/4</td> <td style="width: 15%; text-align: center;">-</td> <td style="width: 15%;"></td> </tr> <tr> <td>01031-05</td> <td style="text-align: center;">-</td> <td style="text-align: center;">5/16</td> <td style="text-align: center;">-</td> <td></td> </tr> <tr> <td>01031-06</td> <td style="text-align: center;">-</td> <td style="text-align: center;">3/8</td> <td style="text-align: center;">-</td> <td></td> </tr> </tbody> </table>						01031-04	-	1/4	-		01031-05	-	5/16	-		01031-06	-	3/8	-																																														
01031-04	-	1/4	-																																																														
01031-05	-	5/16	-																																																														
01031-06	-	3/8	-																																																														
<p><b>01031F</b></p> 	<p><b>No 31F Female Bulkhead Union</b></p>																																																																
<table border="1" style="width: 100%; border-collapse: collapse;"> <thead> <tr> <th style="text-align: left;">Part Number</th> <th style="text-align: center;">Standard Pack</th> <th style="text-align: center;">Tube</th> <th style="text-align: center;">Pipe Thread</th> <th style="text-align: center;">Price Per Piece</th> </tr> </thead> </table>						Part Number	Standard Pack	Tube	Pipe Thread	Price Per Piece																																																							
Part Number	Standard Pack	Tube	Pipe Thread	Price Per Piece																																																													
<table border="1" style="width: 100%; border-collapse: collapse;"> <tbody> <tr> <td style="width: 15%;">01031-F0402</td> <td style="width: 15%; text-align: center;">-</td> <td style="width: 15%; text-align: center;">1/4</td> <td style="width: 15%; text-align: center;">1/8</td> <td style="width: 15%;"></td> </tr> </tbody> </table>						01031-F0402	-	1/4	1/8																																																								
01031-F0402	-	1/4	1/8																																																														
<h2>Solder-On Fittings - Imperial</h2>																																																																	
<p><b>01038</b></p> 	<p><b>No 38 60° Seated Male Union</b></p>																																																																
<table border="1" style="width: 100%; border-collapse: collapse;"> <thead> <tr> <th style="text-align: left;">Part Number</th> <th style="text-align: center;">Standard Pack</th> <th style="text-align: center;">Tube</th> <th style="text-align: center;">Pipe Thread</th> <th style="text-align: center;">Price Per Piece</th> </tr> </thead> </table>						Part Number	Standard Pack	Tube	Pipe Thread	Price Per Piece																																																							
Part Number	Standard Pack	Tube	Pipe Thread	Price Per Piece																																																													
<table border="1" style="width: 100%; border-collapse: collapse;"> <tbody> <tr> <td style="width: 15%;">01038-0302</td> <td style="width: 15%; text-align: center;">-</td> <td style="width: 15%; text-align: center;">1/8</td> <td style="width: 15%; text-align: center;">1/8</td> <td style="width: 15%;"></td> </tr> <tr> <td>01038-0502</td> <td style="text-align: center;">-</td> <td style="text-align: center;">5/16</td> <td style="text-align: center;">1/8</td> <td></td> </tr> <tr> <td>01038-0504</td> <td style="text-align: center;">-</td> <td style="text-align: center;">5/16</td> <td style="text-align: center;">1/4</td> <td></td> </tr> <tr> <td>01038-0506</td> <td style="text-align: center;">-</td> <td style="text-align: center;">5/16</td> <td style="text-align: center;">3/8</td> <td></td> </tr> <tr> <td>01038-0602</td> <td style="text-align: center;">-</td> <td style="text-align: center;">3/8</td> <td style="text-align: center;">1/8</td> <td></td> </tr> <tr> <td>01038-0604</td> <td style="text-align: center;">-</td> <td style="text-align: center;">3/8</td> <td style="text-align: center;">1/4</td> <td></td> </tr> <tr> <td>01038-0606</td> <td style="text-align: center;">-</td> <td style="text-align: center;">3/8</td> <td style="text-align: center;">3/8</td> <td></td> </tr> <tr> <td>01038-0608</td> <td style="text-align: center;">-</td> <td style="text-align: center;">3/8</td> <td style="text-align: center;">1/2</td> <td></td> </tr> <tr> <td>01038-0806</td> <td style="text-align: center;">-</td> <td style="text-align: center;">1/2</td> <td style="text-align: center;">3/8</td> <td></td> </tr> <tr> <td>01038-0808</td> <td style="text-align: center;">-</td> <td style="text-align: center;">1/2</td> <td style="text-align: center;">1/2</td> <td></td> </tr> <tr> <td>01038-1208</td> <td style="text-align: center;">-</td> <td style="text-align: center;">3/4</td> <td style="text-align: center;">1/2</td> <td></td> </tr> <tr> <td>01038-1212</td> <td style="text-align: center;">-</td> <td style="text-align: center;">3/4</td> <td style="text-align: center;">3/4</td> <td></td> </tr> </tbody> </table>						01038-0302	-	1/8	1/8		01038-0502	-	5/16	1/8		01038-0504	-	5/16	1/4		01038-0506	-	5/16	3/8		01038-0602	-	3/8	1/8		01038-0604	-	3/8	1/4		01038-0606	-	3/8	3/8		01038-0608	-	3/8	1/2		01038-0806	-	1/2	3/8		01038-0808	-	1/2	1/2		01038-1208	-	3/4	1/2		01038-1212	-	3/4	3/4	
01038-0302	-	1/8	1/8																																																														
01038-0502	-	5/16	1/8																																																														
01038-0504	-	5/16	1/4																																																														
01038-0506	-	5/16	3/8																																																														
01038-0602	-	3/8	1/8																																																														
01038-0604	-	3/8	1/4																																																														
01038-0606	-	3/8	3/8																																																														
01038-0608	-	3/8	1/2																																																														
01038-0806	-	1/2	3/8																																																														
01038-0808	-	1/2	1/2																																																														
01038-1208	-	3/4	1/2																																																														
01038-1212	-	3/4	3/4																																																														

## Solder-On Fittings - Imperial

<p style="font-size: 1.2em; font-weight: bold;">01038F</p>	<p style="text-align: center; font-weight: bold;">No 38F 60° Seated Female Union</p> <table border="1" style="width: 100%; border-collapse: collapse;"> <thead> <tr style="background-color: #ffffcc;"> <th style="text-align: left;">Part Number</th> <th style="text-align: center;">Standard Pack</th> <th style="text-align: center;">Tube</th> <th style="text-align: center;">Pipe Thread</th> <th style="text-align: center;">Price Per Piece</th> </tr> </thead> <tbody> <tr> <td>01038-F0502</td> <td style="text-align: center;">-</td> <td style="text-align: center;">5/16</td> <td style="text-align: center;">1/8</td> <td></td> </tr> <tr> <td>01038-F0504</td> <td style="text-align: center;">-</td> <td style="text-align: center;">5/16</td> <td style="text-align: center;">1/4</td> <td></td> </tr> <tr> <td>01038-F0506</td> <td style="text-align: center;">-</td> <td style="text-align: center;">5/16</td> <td style="text-align: center;">3/8</td> <td></td> </tr> </tbody> </table>	Part Number	Standard Pack	Tube	Pipe Thread	Price Per Piece	01038-F0502	-	5/16	1/8		01038-F0504	-	5/16	1/4		01038-F0506	-	5/16	3/8																					
Part Number	Standard Pack	Tube	Pipe Thread	Price Per Piece																																					
01038-F0502	-	5/16	1/8																																						
01038-F0504	-	5/16	1/4																																						
01038-F0506	-	5/16	3/8																																						
<p style="font-size: 1.2em; font-weight: bold;">01039</p>	<p style="text-align: center; font-weight: bold;">No 39 60° Seated Tube Union</p> <table border="1" style="width: 100%; border-collapse: collapse;"> <thead> <tr style="background-color: #ffffcc;"> <th style="text-align: left;">Part Number</th> <th style="text-align: center;">Standard Pack</th> <th style="text-align: center;">Tube</th> <th style="text-align: center;">Pipe Thread</th> <th style="text-align: center;">Price Per Piece</th> </tr> </thead> <tbody> <tr> <td>01039-05</td> <td style="text-align: center;">-</td> <td style="text-align: center;">5/16</td> <td style="text-align: center;">1/4</td> <td></td> </tr> <tr> <td>01039-06</td> <td style="text-align: center;">-</td> <td style="text-align: center;">3/8</td> <td style="text-align: center;">3/8</td> <td></td> </tr> <tr> <td>01039-08</td> <td style="text-align: center;">-</td> <td style="text-align: center;">1/2</td> <td style="text-align: center;">1/2</td> <td></td> </tr> </tbody> </table>	Part Number	Standard Pack	Tube	Pipe Thread	Price Per Piece	01039-05	-	5/16	1/4		01039-06	-	3/8	3/8		01039-08	-	1/2	1/2																					
Part Number	Standard Pack	Tube	Pipe Thread	Price Per Piece																																					
01039-05	-	5/16	1/4																																						
01039-06	-	3/8	3/8																																						
01039-08	-	1/2	1/2																																						
<p style="font-size: 1.2em; font-weight: bold;">01044</p>	<p style="text-align: center; font-weight: bold;">Solder-On Tail</p> <table border="1" style="width: 100%; border-collapse: collapse;"> <thead> <tr style="background-color: #ffffcc;"> <th style="text-align: left;">Part Number</th> <th style="text-align: center;">Standard Pack</th> <th style="text-align: center;">Tube</th> <th style="text-align: center;">Pipe Thread</th> <th style="text-align: center;">Price Per Piece</th> </tr> </thead> <tbody> <tr> <td>01044-03</td> <td style="text-align: center;">-</td> <td style="text-align: center;">3/16</td> <td></td> <td></td> </tr> <tr> <td>01044-04</td> <td style="text-align: center;">-</td> <td style="text-align: center;">1/4</td> <td></td> <td></td> </tr> <tr> <td>01044-05</td> <td style="text-align: center;">-</td> <td style="text-align: center;">5/16</td> <td></td> <td></td> </tr> <tr> <td>01044-0504</td> <td style="text-align: center;">-</td> <td style="text-align: center;">5/16x1/4</td> <td></td> <td></td> </tr> <tr> <td>01044-06</td> <td style="text-align: center;">-</td> <td style="text-align: center;">3/8</td> <td></td> <td></td> </tr> <tr> <td>01044-08</td> <td style="text-align: center;">-</td> <td style="text-align: center;">1/2</td> <td></td> <td></td> </tr> </tbody> </table>	Part Number	Standard Pack	Tube	Pipe Thread	Price Per Piece	01044-03	-	3/16			01044-04	-	1/4			01044-05	-	5/16			01044-0504	-	5/16x1/4			01044-06	-	3/8			01044-08	-	1/2							
Part Number	Standard Pack	Tube	Pipe Thread	Price Per Piece																																					
01044-03	-	3/16																																							
01044-04	-	1/4																																							
01044-05	-	5/16																																							
01044-0504	-	5/16x1/4																																							
01044-06	-	3/8																																							
01044-08	-	1/2																																							
<p style="font-size: 1.2em; font-weight: bold;">01045</p>	<p style="text-align: center; font-weight: bold;">No.45 Solder-On Nut</p> <table border="1" style="width: 100%; border-collapse: collapse;"> <thead> <tr style="background-color: #ffffcc;"> <th style="text-align: left;">Part Number</th> <th style="text-align: center;">Standard Pack</th> <th style="text-align: center;">Tube</th> <th style="text-align: center;">Pipe Thread</th> <th style="text-align: center;">Price Per Piece</th> </tr> </thead> <tbody> <tr> <td>01045-03</td> <td style="text-align: center;">-</td> <td style="text-align: center;">3/16</td> <td></td> <td></td> </tr> <tr> <td>01045-04</td> <td style="text-align: center;">-</td> <td style="text-align: center;">1/4</td> <td></td> <td></td> </tr> <tr> <td>01045-05</td> <td style="text-align: center;">-</td> <td style="text-align: center;">5/16</td> <td></td> <td></td> </tr> <tr> <td>01045-06</td> <td style="text-align: center;">-</td> <td style="text-align: center;">3/8</td> <td></td> <td></td> </tr> <tr> <td>01045-08</td> <td style="text-align: center;">-</td> <td style="text-align: center;">1/2</td> <td></td> <td></td> </tr> <tr> <td>01045-12</td> <td style="text-align: center;">-</td> <td style="text-align: center;">3/4</td> <td></td> <td></td> </tr> <tr> <td>01045-16</td> <td style="text-align: center;">-</td> <td style="text-align: center;">1"</td> <td></td> <td></td> </tr> </tbody> </table>	Part Number	Standard Pack	Tube	Pipe Thread	Price Per Piece	01045-03	-	3/16			01045-04	-	1/4			01045-05	-	5/16			01045-06	-	3/8			01045-08	-	1/2			01045-12	-	3/4			01045-16	-	1"		
Part Number	Standard Pack	Tube	Pipe Thread	Price Per Piece																																					
01045-03	-	3/16																																							
01045-04	-	1/4																																							
01045-05	-	5/16																																							
01045-06	-	3/8																																							
01045-08	-	1/2																																							
01045-12	-	3/4																																							
01045-16	-	1"																																							
<p style="font-size: 1.2em; font-weight: bold;">01050</p>	<p style="text-align: center; font-weight: bold;">No.50B 60° Seated Tube Tee</p> <table border="1" style="width: 100%; border-collapse: collapse;"> <thead> <tr style="background-color: #ffffcc;"> <th style="text-align: left;">Part Number</th> <th style="text-align: center;">Standard Pack</th> <th style="text-align: center;">Tube</th> <th style="text-align: center;">Pipe Thread</th> <th style="text-align: center;">Price Per Piece</th> </tr> </thead> <tbody> <tr> <td>01050-B05</td> <td style="text-align: center;">-</td> <td style="text-align: center;">5/16</td> <td></td> <td></td> </tr> <tr> <td>01050-B06</td> <td style="text-align: center;">-</td> <td style="text-align: center;">3/8</td> <td></td> <td></td> </tr> <tr> <td>01050-B08</td> <td style="text-align: center;">-</td> <td style="text-align: center;">1/2</td> <td></td> <td></td> </tr> </tbody> </table>	Part Number	Standard Pack	Tube	Pipe Thread	Price Per Piece	01050-B05	-	5/16			01050-B06	-	3/8			01050-B08	-	1/2																						
Part Number	Standard Pack	Tube	Pipe Thread	Price Per Piece																																					
01050-B05	-	5/16																																							
01050-B06	-	3/8																																							
01050-B08	-	1/2																																							

Solder-on Fittings

# SAE Inverted Flare Fittings

<b>01058</b> 	<b>No 58S Steel Inverted Flare Nut</b>				
	Part Number	Standard Pack	Tube	Pipe Thread	Price Per Piece
	01058-S02	-	1/8		
	01058-S03	-	3/16		
	01058-10MM03	-	3/16x10mm		
	01058-S04	-	1/4		
	01058-S05	-	5/16		
01058-S06	-	3/8			
<b>01058L</b> 	<b>No 58SL Steel Long Inverted Flare Nut</b>				
	Part Number	Standard Pack	Tube	Pipe Thread	Price Per Piece
	01058-SLR03	-	16 rec'd END		
	01058-SL03	-	3/16		
	01058-SL04	-	1/4		
	01058-SL05	-	5/16		

**S  
A  
E**



# Fleet Fit



Fleet fit push-in fittings are now available from Titon. Please call us for sizes, prices and any other information you require.

IMPERIAL		METRIC
<p>NO FF3 MALE CONNECTOR 35003</p>	<p>NO.FF13 MALE RUN TEE 35013</p>	<p>NO FFM3 MALE CONNECTOR 35003 - M</p>
<p>NO. FF4 TUBE UNION 35004</p>	<p>NO.FF11 TUBE ELBOW 35011</p>	<p>NO. FFM4 TUBE UNION 35004 - M</p>
<p>NO.FF5 MALE ELBOW 35005</p>	<p>NO. FF14 TUBE TEE 35014</p>	<p>NO.FFM5 MALE ELBOW 35005-M</p>
<p>NO.FF12 MALE BRANCH TEE 35012</p>	<p>NO. FF31F FEMALE BULKHEAD 35031 - F</p>	<p>NO.FFM12 MALE BRANCH TEE 35012 - M</p>
<p>NO.FF5 45° MALE ELBOW 35005 - 45</p>	<p>NO. FF31 BULKHEAD UNION 35031</p>	<p>NO.FFM11 TUBE ELBOW 35011 - M</p>
	<p>NO.FF64 BLANKING PLUG 35064</p>	<p>NO. FFM14 TUBE TEE 35014 - M</p>
		<p>NO. FFM31 BULKHEAD UNION 35031 - M</p>

**MISC**

Working pressure 0 - 1050kPa (0 - 150psi) designed for - heavy transport industry Airbrake systems - Airbrake tube SAE J844 Dot - rated brass

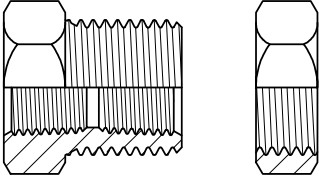
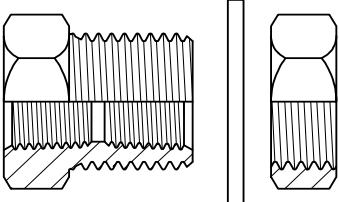
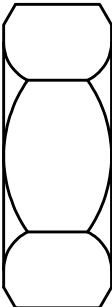
# Miscellaneous

<p><b>BUL</b></p> 	<p align="center"><b>Lightweight Bulkhead Union</b> Complete with nut.</p> <table border="1"> <thead> <tr> <th>Part Number</th> <th>Standard Pack</th> <th>Length (mm)</th> <th>Male Thread</th> <th>Pipe Thread</th> <th>Price Per Piece</th> </tr> </thead> <tbody> <tr> <td>BU02L</td> <td>2</td> <td>27</td> <td>1/4 BSPF</td> <td>1/8 BSPP</td> <td></td> </tr> <tr> <td>BU04L</td> <td>2</td> <td>30</td> <td>3/8 BSPF</td> <td>1/4 BSPP</td> <td></td> </tr> </tbody> </table>	Part Number	Standard Pack	Length (mm)	Male Thread	Pipe Thread	Price Per Piece	BU02L	2	27	1/4 BSPF	1/8 BSPP		BU04L	2	30	3/8 BSPF	1/4 BSPP																		
Part Number	Standard Pack	Length (mm)	Male Thread	Pipe Thread	Price Per Piece																															
BU02L	2	27	1/4 BSPF	1/8 BSPP																																
BU04L	2	30	3/8 BSPF	1/4 BSPP																																
<p><b>BU</b></p> 	<p align="center"><b>Bulkhead Union</b> Complete with lock washer and nut.</p> <table border="1"> <thead> <tr> <th>Part Number</th> <th>Standard Pack</th> <th>Length (Inches)</th> <th>Male Thread</th> <th>Pipe Thread</th> <th>Price Per Piece</th> </tr> </thead> <tbody> <tr> <td>BU02</td> <td>2</td> <td>1.5</td> <td>5/8 UNF</td> <td>1/8 BSPT</td> <td></td> </tr> <tr> <td>BU04</td> <td>2</td> <td>1.5</td> <td>3/4 UNF</td> <td>1/4 BSPT</td> <td></td> </tr> <tr> <td>BU06</td> <td>2</td> <td>1.5</td> <td>7/8 UNF</td> <td>3/8 BSPT</td> <td></td> </tr> </tbody> </table>	Part Number	Standard Pack	Length (Inches)	Male Thread	Pipe Thread	Price Per Piece	BU02	2	1.5	5/8 UNF	1/8 BSPT		BU04	2	1.5	3/4 UNF	1/4 BSPT		BU06	2	1.5	7/8 UNF	3/8 BSPT												
Part Number	Standard Pack	Length (Inches)	Male Thread	Pipe Thread	Price Per Piece																															
BU02	2	1.5	5/8 UNF	1/8 BSPT																																
BU04	2	1.5	3/4 UNF	1/4 BSPT																																
BU06	2	1.5	7/8 UNF	3/8 BSPT																																
<p><b>111</b></p> 	<p align="center"><b>Lock Nut</b></p> <table border="1"> <thead> <tr> <th>Part Number</th> <th>Standard Pack</th> <th>Tube</th> <th>Thread</th> <th>Price Per Piece</th> </tr> </thead> <tbody> <tr> <td>11102</td> <td>5</td> <td>-</td> <td>G 1/8</td> <td></td> </tr> <tr> <td>11104</td> <td>5</td> <td>-</td> <td>G 1/4</td> <td></td> </tr> <tr> <td>11106</td> <td>5</td> <td>-</td> <td>G 3/8</td> <td></td> </tr> <tr> <td>11108</td> <td>5</td> <td>-</td> <td>G 1/2</td> <td></td> </tr> <tr> <td>11112</td> <td>-</td> <td>-</td> <td>G 3/4</td> <td></td> </tr> <tr> <td>11116</td> <td>1</td> <td>-</td> <td>G 1"</td> <td></td> </tr> </tbody> </table>	Part Number	Standard Pack	Tube	Thread	Price Per Piece	11102	5	-	G 1/8		11104	5	-	G 1/4		11106	5	-	G 3/8		11108	5	-	G 1/2		11112	-	-	G 3/4		11116	1	-	G 1"	
Part Number	Standard Pack	Tube	Thread	Price Per Piece																																
11102	5	-	G 1/8																																	
11104	5	-	G 1/4																																	
11106	5	-	G 3/8																																	
11108	5	-	G 1/2																																	
11112	-	-	G 3/4																																	
11116	1	-	G 1"																																	
<p><b>06775</b></p>  <p>700 PSI BURST PRESSURE 125 PSI WORKING PRESSURE</p>	<p align="center"><b>Self Store Fitting</b></p>																																			

**MISC**

# Miscellaneous

MISC

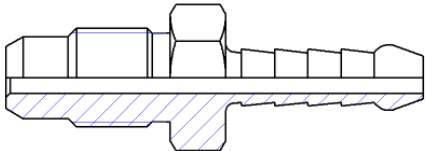
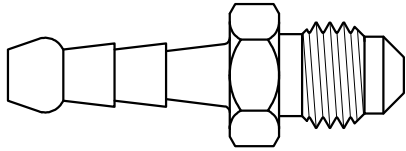
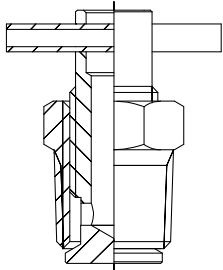
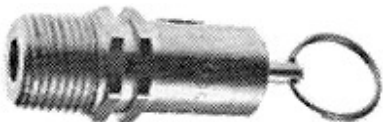
Fuel Filter Adaptor - Long Nose					
Part Number	Standard Pack	Tube	Thread	Price Per Piece	
06C-604	10	1/4	1/2 x 20 TPI		
06C-605	10	5/16	1/2 x 20 TPI		
06C-606	10	3/8	1/2 x 20 TPI		
06C-704		1/4 BSP			
06C-804	ELBOW	1/4 BSP			
Fuel Filter Adaptor					
Part Number	Standard Pack	Tube	Thread	Price Per Piece	
6C0405	10	1/4	1/2 x 20 TPI		
6C0505	10	5/16	1/2 x 20 TPI		
6C0605	10	3/8	1/2 x 20 TPI		
Drain Cock					
Part Number	Standard Pack	Tube	Pipe Thread	Price Per Piece	
DC2	1	-	1/8 BSPT		
DC4	1	-	1/4 BSPT		
DC6	1	-	3/8 BSPT		
DC8	1	-	1/2 BSPT		
Relief Valve					
Part Number	Standard Pack	Release Pressure	Pipe Thread	Price Per Piece	
046406-1050-04	1	1050 kPa	1/4 BSPT		
046406-1050-06	1	1050 kPa	3/8 BSPT		
046406-1050-08	1	1050 kPa	1/2 BSPT		

# Grease Gun

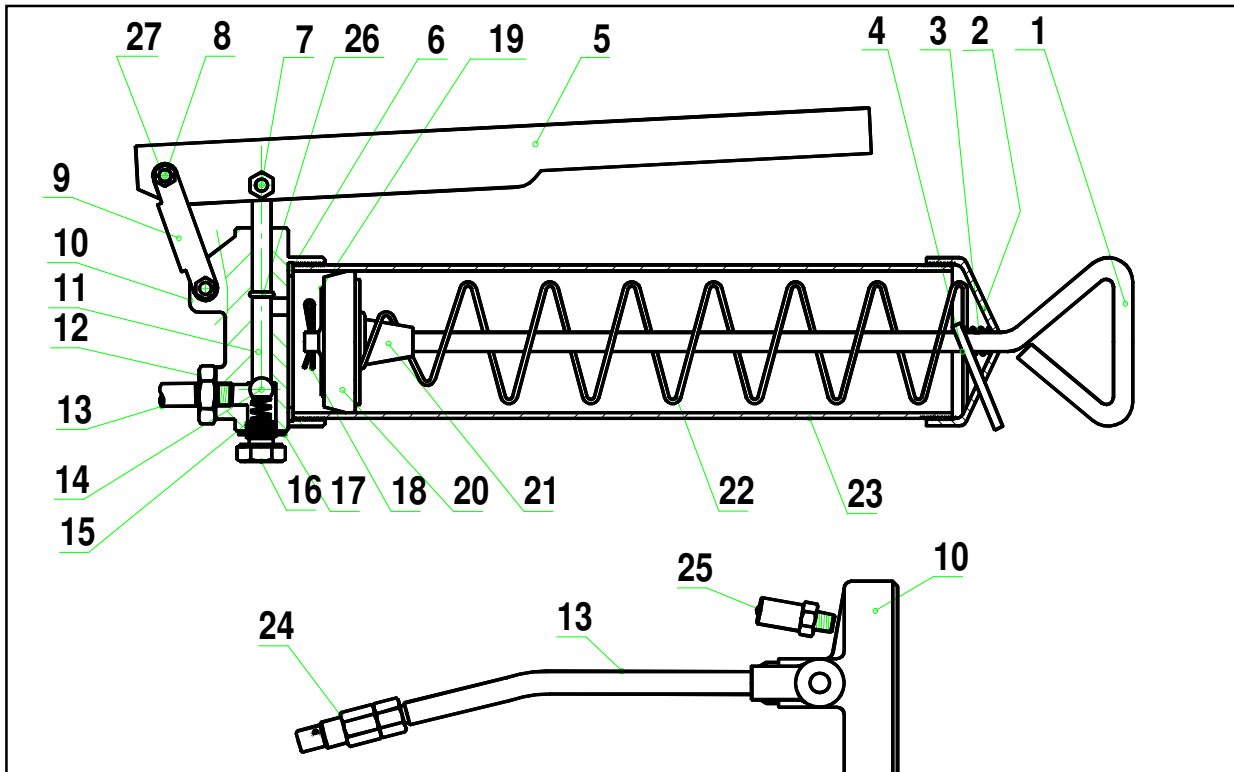

**G  
R  
E  
A  
S  
E**

#	DESCRIPTION	PART #	#	DESCRIPTION	PART #	#	DESCRIPTION	PART #
1	PLUNGER ROD & HANDLE	CGA15	11	PISTON	UT5	21	PLUNGER GUIDER	UT31
2	END CAP	CGA4	12	LOCK NUT	UT25	22	PLUNGER SPRING	CG17
3	LATCH SPRING	UT27	13	GREASE PIPE	UT23	23	CG450 BARREL	CG1
4	LATCH	UT26	14	VALVE BALL 13/32" DIA	UT21	24	GREASE POINT ASSEMBLY	SGP100
5	LEVER	UT7	15	VALVE SPRING	UT20	25	BLEEDER VALVE	BV100
6	HEAD GASKET	CG3	16	VALVE BODY	UT19	26	PISTON O'RING	'010
7	PISTON SCREW	UT6	17	WASHER FOR UT19	UT18	27	NYLOCK NUT	UT10
8	LEVER SCREW	UT9	18	SPLIT PIN 3/4" x 1/8"	UTA16		CG450 LABEL	UT32
9	CONNECTING LINK	UT8	19	FRONT WASHER	CG12	-	INSTRUCTION SHEET	UT33
10	HEAD	CG2	20	RUBBER PLUNGER	CG13	-		

CG450	Part Number	Standard Pack	Price Per Piece
	CG450	1	
	Part Number	Standard Pack	Price Per Piece
Seal Kit	CG450SK	1	
Plunger Kit	CG450PK	1	

# Grease Gun

## Grease Gun Spares

### High Pressure Lever Type Grease Gun

Pressure: 41000 kPa, 6000 PSI

Capacity: 450g Cartridge or 570g Bulk Grease

**G  
R  
E  
A  
S  
E**

Part Number	Standard Pack	Description	Price Per Piece
BV100	1	Grease Gun Bleeder Valve	
CG1	1	CG450 Barrel	
CG10	1	Guiding Washer	
CG12	1	Following Washer	
CG13	1	Plunger Cup Washer	
CG17	1	Grease Gun Plunger	
CG2	1	CG450 Head	
CG3	1	Head Gasket	
CGA15	1	Plunger Rod and Handle	
CGA4	1	End Cap	
UT23	1	Grease Pipe	
UT26	1	Latch	
UT27	1	Latch Spring	
UT5	1	Piston	
UT6	1	Piston Rivet	
UT7	1	Lever	
UT8	1	Connecting Link	
UT9	1	Lever Rivet	
FH8	1	8" Flexible Hose	
FH10	1	10" Flexible Hose	
FH12	1	12" Flexible Hose	
FH15	1	15" Flexible Hose	
FH18	1	18" Flexible Hose	
FH36	1	36" Flexible Hose	
FVA100	1	Filler Valve	
HC100	1	Hydraulic Coupler	
HCA100	1	3 Jaw Hydraulic Coupler	
SGP1	1	Needle Point	
SGP100	1	Grease Point Assembly	
SGP2	1	Needle Point Safety Sleeve	
SGP3	1	Needle Point Adaptor	

# Air Duster

## ROBUST AIR DUSTER FOR GENERAL COMMERCIAL AND PRIVATE USE.

- DURABLE DIE-CAST ALUMINIUM BODY TO WITHSTAND EVEN THE MOST DEMANDING USE
- POSITIVE TRIGGER ACTION
- 1/4 BSP INLET ACCEPTS MANY DIFFERENT HOSE CONNECTORS.
- INTEGRAL HOOK FOR EASY STORAGE

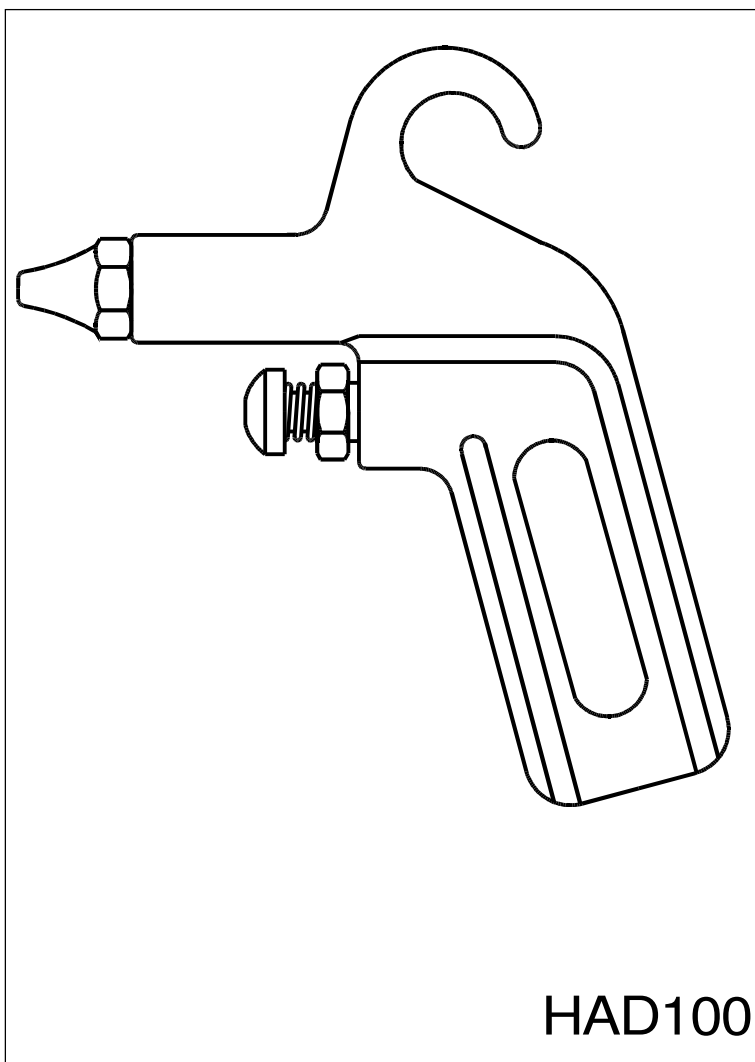

Part Number	Standard Pack	Outlet Diameter	Pipe Thread	Price Per Piece
HAD100	1	2 mm	1/4 BSPP	

**AIR DUSTER**

# Hose Clips

## 295



### Mild Steel Jubilee Hose Clips

These clips are zinc plated and approved to BS5315.

Part Number	Standard Pack	Size	Diameter		Price Per Piece
			min (mm)	max (mm)	
295-012	10	OOO	9.5	12	
295-016	10	MOO	11	16	
295-020	10	OO	13	20	
295-022	10	0	16	22	
295-025	10	OX	18	25	
295-030	10	1A	22	30	
295-035	10	1	25	35	
295-040	10	1X	30	40	
295-050	10	2A	35	50	
295-055	10	2	40	55	
295-060	10	2X	45	60	
295-070	10	3	55	70	
295-080	10	3X	60	80	
295-090	10	4	70	90	
295-100	10	4X	85	100	
295-120	10	5	90	120	
295-140	10	6	120	140	
295-165	10	7	135	165	
295-190	10	7½	160	190	

## 296



### Stainless Steel Jubilee Hose Clips

These clips are approved to BS5315.

Part Number	Standard Pack	Size	Diameter		Price Per Piece
			min (mm)	max (mm)	
296-012	10	OOO	9.5	12	
296-016	10	MOO	11	16	
296-020	10	OO	13	20	
296-022	10	0	16	22	
296-025	10	OX	18	25	
296-030	10	1A	22	30	
296-035	10	1	25	35	
296-040	10	1X	30	40	
296-050	10	2A	35	50	
296-055	10	2	40	55	
296-060	10	2X	45	60	
296-070	10	3	55	70	
296-080	10	3X	60	80	
296-090	10	4	70	90	
296-100	10	4X	85	100	
296-120	10	5	90	120	
296-140	10	6	120	140	
296-165	10	7	135	165	

**C L I P S**

# Hose Clips

## Oetiker 2-Ear Clamps - 5000 kPa

Select nominal clamp size nearest to, but larger than hose OD

Part Number	Standard Pack	Nominal Size	Open Size mm	Closed Size mm	Price Per Piece
1105-03	25	3/16	5	3	
1107-04	25	1/4	7	5	
1109-05	25	5/16	9	7	
1111-07	25	7/16	11	9	
1113-08	25	1/2	13	11	
1115-09	25	9/16	15	13	
1118-10	25	5/8	18	15	
1120-12	25	3/4	20	17	
1123-14	25	7/8	23	20	
1125-15	25	15/16	25	22	
1127-16	25	1"	27	23	
1128-17	25	1" 1/16	28	25	
1134-21	25	1" 5/16	34	31	

11



C  
L  
I  
P  
S



# Ball Valves (AGA GAS APPROVED)

## 070

**"BERLIN"**  
**FULL FLOW BALL VALVE**  
**FOR GAS ISO 7/1**  
**Rp FEMALE/FEMALE**

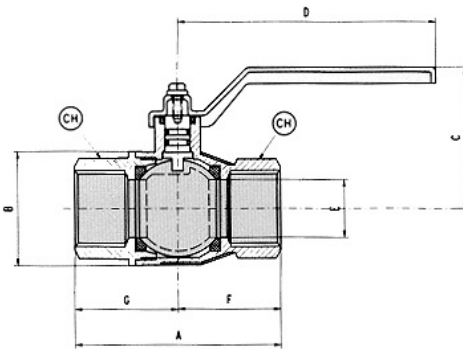

**TECHNICAL FEATURES:**

Suitable for industrial, pneumatic, domestic and hydraulic installation: hot water, dry steam, unleaded gasoline, fuel, gas-oil, kerosene, oils, **GAS**, compressed air, etc. ( not suitable with methyl alcohol and saturated steam).

Maximum working Temperature: 60°C

Minimum working temperature: -20°C

Working pressure for gas: PN1 to PN4 (see diagram on page 68), for other purposes (see diagram)

Available in all sizes from 1/4" up to 2"

Thread to BS21-DIN 2999-ISO 7/1 Rp parallel female/female.

CODE	V301	V302	V303	V304	V305	V306	V307	V308
SIZE	1/4"	3/8"	1/2"	3/4"	1"	1 1/4"	1 1/2"	2"
A	51	60	75	80	90	110	120	140
B	25.5	25.5	32.5	42	49.5	59.5	72	86
C	40	40	50	59	63	77	91	97
D	80	80	89	113	113	138	158	158
E	10	10	15	20	25	32	40	50
F	25.5	29.75	37.5	40	45.25	55	60	70.25
G	25.5	29.75	37.5	40	45.25	55	60	70.25
<b>PRICE</b>								

## 071

**"BERLIN"**  
**FULL FLOW BALL VALVE**  
**FOR GAS ISO 7/1**  
**R MALE/FEMALE**

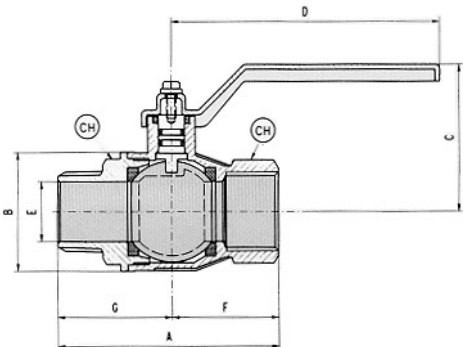

**TECHNICAL FEATURES:**

Suitable for industrial, pneumatic, domestic and hydraulic installation: hot water, dry steam, unleaded gasoline, fuel, gas-oil, kerosene, oils, **GAS**, compressed air, etc. ( not suitable with methyl alcohol and saturated steam).

Maximum working Temperature: 60°C

Minimum working temperature: -20°C

Working pressure for gas: PN1 to PN4 (see diagram on page 68), for other purposes (see diagram)

Available in all sizes from 1/4" up to 2"

Thread to BS21-DIN 2999-ISO 7/1 Rp parallel female/female.

CODE	V321	V322	V323	V324	V325	V326	V327	V328
SIZE	1/4"	3/8"	1/2"	3/4"	1"	1 1/4"	1 1/2"	2"
A	58	63	77	84	92	110	121	141
B	25.5	25.5	32.5	42	49.5	59.5	72	86
C	40	40	50	59	63	77	91	97
D	80	80	89	113	113	138	158	158
E	10	10	15	20	25	32	40	50
F	28.75	31.5	38.5	42	46	55	60.5	70.5
G	28.75	31.5	38.5	42	46	55	60.5	70.5
<b>PRICE</b>								

**V  
A  
L  
V  
E  
S**

# Ball Valves (AGA GAS APPROVED)

Nickle Plated Brass

## 072

**"BERLIN"**  
**FULL FLOW BALL VALVE**  
**FOR GAS ISO 7/1**  
**Rp FEMALE/FEMALE**  
**T HANDLE**

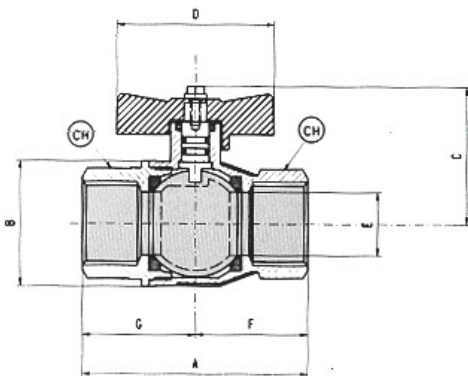

**TECHNICAL FEATURES:**

Suitable for industrial, pneumatic, domestic and hydraulic installation: hot water, dry steam, gasoline, fuel, gas-oil, kerosene, oils, GAS, compressed air, etc. (not suitable with methyl alcohol and saturated steam).

Maximum working Temperature: 60°C

Minimum working temperature: -20°C

Working pressure for gas: PN1 to PN4 (see diagram on page 68), for other purposes (see diagram)

Available in all sizes from 1/4" up to 2"

Thread to BS21-DIN 2999-ISO 7/1 Rp parallel female/female.

CODE	V351	V352	V353	V354	V355
SIZE	1/4"	3/8"	1/2"	3/4"	1"
A	51	60	75	80	90
B	25.5	25.5	32.5	42	49.5
C	37	37	47	49	52
D	54	54	54	63	63
E	10	10	15	20	25
F	25.5	29.75	37.5	40	45.25
G	25.5	29.75	37.5	40	45.25
PRICE					

## 073

**"BERLIN"**  
**FULL FLOW BALL VALVE**  
**FOR GAS ISO 7/1**  
**R MALE/FEMALE**  
**T HANDLE**

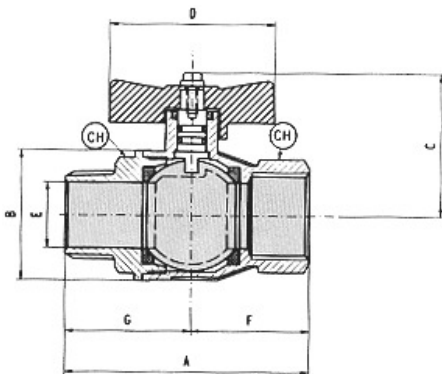

**TECHNICAL FEATURES:**

Suitable for industrial, pneumatic, domestic and hydraulic installation: hot water, dry steam, unleaded gasoline, fuel, gas-oil, kerosene, oils, GAS, compressed air, etc. (not suitable with methyl alcohol and saturated steam).

Maximum working Temperature: 60°C

Minimum working temperature: -20°C

Working pressure for gas: PN1 to PN4 (see diagram on page 68), for other purposes (see diagram)

Available in all sizes from 1/4" up to 2"

Thread to BS21-DIN 2999-ISO 7/1 Rp parallel female/female.

CODE	V371	V372	V373	V374	V375
SIZE	1/4"	3/8"	1/2"	3/4"	1"
A	58	63	77	84	92
B	25.5	25.5	32.5	42	49.5
C	37	37	47	49	52
D	54	54	54	63	63
E	10	10	15	20	25
F	28.75	31.5	38.5	42	46
G	28.75	31.5	38.5	42	46
PRICE					

**V  
A  
L  
V  
E  
S**

# Ball Valves (AGA GAS APPROVED)

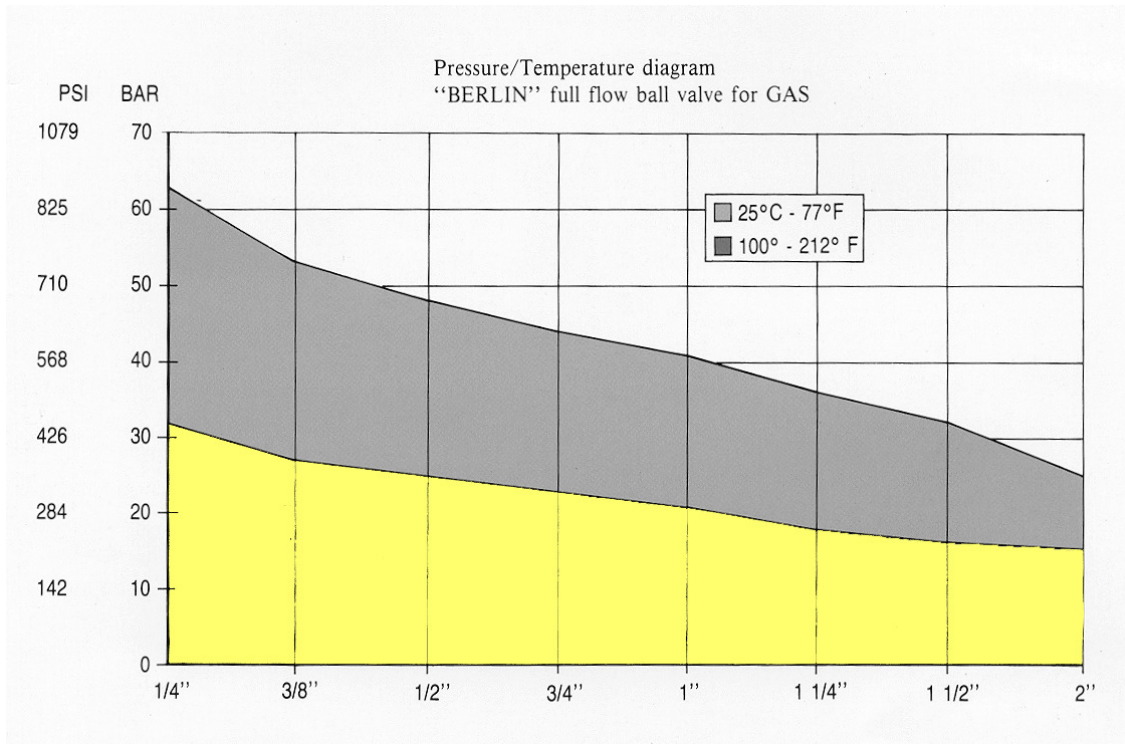

# Product Index

## Symbols

45° Flare	4
45° Gas Flare	10
45° Inverted Flare	11

## A

Air Duster	56
Airbrake	39
Airline	33

## B

BALL VALVES 59

## C

Compression Fittings	
13	
Conversion Tables	42

## F

Fleet Fit	51
-----------	----

## G

Grease Gun	54
------------	----

## H

Hose Clips	57
------------	----

## L

Lever Taps & Cockse	
43	43

## M

Metric Compression	
Fittings	20
Metric Pipe Fittings	30
Miscellaneous	52

## N

Needle Valves	45
NPT Pipe Fittings	32

## P

Pipe Fittings	23
Profiles	12

## S

SAE Inverted Flare Fittings	
50	
Solder-On Fittings -	
Imperial	48-49



# Order Form



Photo-Copy and post, fax, phone or email to...

**TITON**

PO Box 13-349, Onehunga, Auckland, New Zealand.

Telephone (64)-9-634 2894, Fax (64)-9-634 0030

email : sales@titon.co.nz

Date:      /      /

Charge To: \_\_\_\_\_

Order No: \_\_\_\_\_

\_\_\_\_\_

Ordered By: \_\_\_\_\_

\_\_\_\_\_

Special Instructions: \_\_\_\_\_

Ship To: \_\_\_\_\_

\_\_\_\_\_

\_\_\_\_\_

Place out of stock items on back order?    Yes     No

Qty	Product Code or Description	Unit Cost	Discount